

**MODEL NO.
637.99743**

**HOW TO
ORDER
REPLACEMENT
PARTS**

**OWNER'S
MANUAL**

CARTRIDGE TELEGAMES™ SYSTEM VIDEO ARCADE™



The Model Number of your Video Arcade is located on the bottom of the console unit. Always mention the complete Model Number when requesting service or repair parts for your Video Arcade.

| Part No. | Part Name |
|-------------|---------------------------------|
| CA011302-02 | Target-Fun Tele-Games Cartridge |
| CA010972 | Joystick Controller |
| CA010950 | Paddle Controllers (set of two) |
| CA010112 | TV/Game Switch Box |
| CO10472 | AC Power Supply |
| 88-1004 | Rubber Foot |
| CO10962 | Owner's Manual |

All parts listed herein may be ordered directly from any SEARS, ROEBUCK AND CO. retail or catalog store.

WHEN ORDERING REPAIR PARTS, ALWAYS GIVE THE FOLLOWING INFORMATION:

- | | |
|-----------------|---------------------|
| 1. Part Number | 2. Part Description |
| 3. Model Number | 4. Name of Item |

If the parts are not stocked locally, your order will be electronically transmitted to a Sears Repair Parts Distribution Center for expedited handling.

FULL 90-DAY WARRANTY ON VIDEO ARCADE

For 90 days from date of purchase, Sears will repair this Video Arcade Tele-Game, free of charge, if defective in material or workmanship.

Warranty service is available by simply returning the Video Arcade Tele-Game to the nearest Sears store throughout the United States.

This warranty gives you specific legal rights, and you may also have other rights which vary from state to state.

SEARS, ROEBUCK AND CO.
BSC 41-3
Sears Tower
Chicago, IL 60684

Sears 
SPORTS CENTER
home of the Ted Williams brand

MODEL NO.
637.99743

- assembly
- operation
- troubleshooting
- replacement parts

**OWNER'S
MANUAL**

CARTRIDGE TELEGAMES^{T.M.} SYSTEM VIDEO ARCADE^{T.M.}

*Sears * Best*



UNPACK GAME

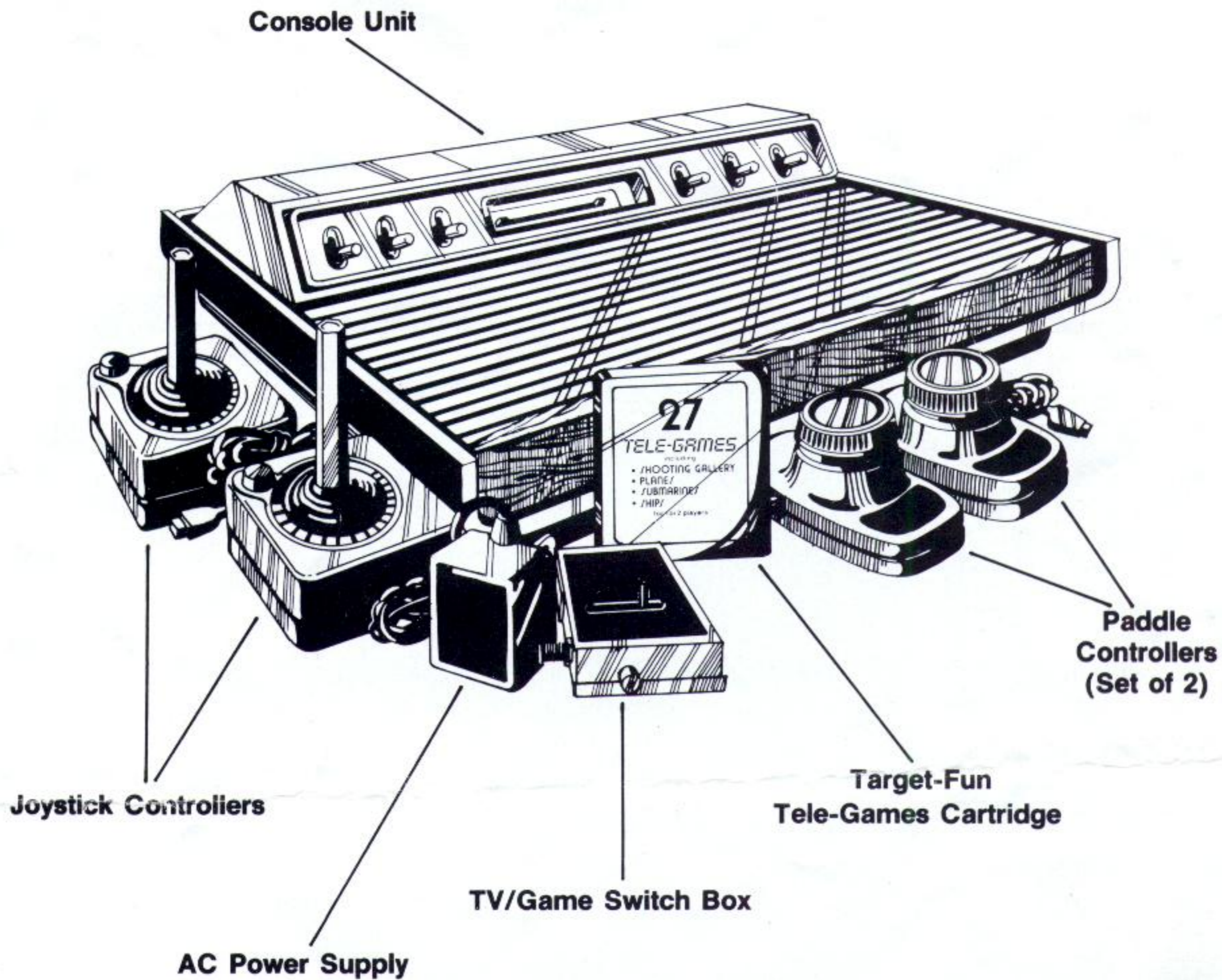

Figure 1 — Parts of Sears Cartridge Tele-Games System Video Arcade™

When you remove your Sears Cartridge Tele-Games System Video Arcade™ from the box, you should have:

- Video Arcade Console Unit
- Target-Fun Telegames Cartridge
- 2 Joystick Controllers (for use with the Target-Fun Tele-Games Cartridge)
- Set of 2 Paddle Controllers (for use with additional Tele-Games Cartridges, sold separately)
- AC Power Supply
- TV/Game Switch Box with twin-lead wires

The only tool needed to set up your Video Arcade is a flat-head screwdriver. See further instructions on page 3.

INSTALL SWITCH BOX

Your TV/Game Switch Box attaches easily to your television's VHF antenna screws. Find the picture that looks the most like the back of your television and follow those instructions. A flat-head screwdriver is required.

A. If your television has four screws only:

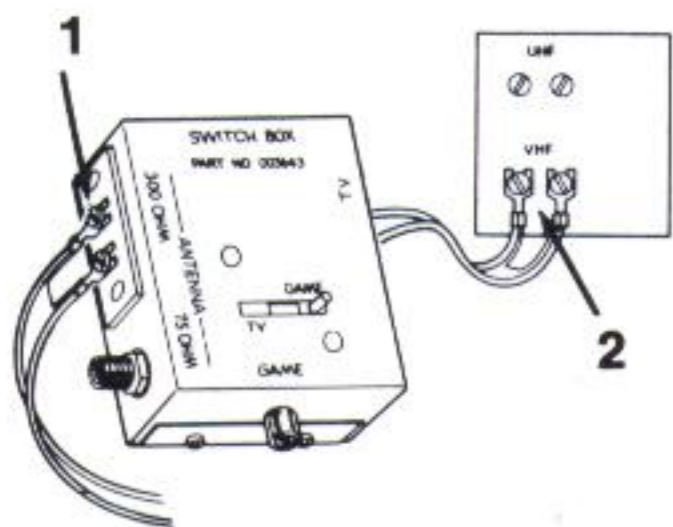

1. Disconnect the twin-lead wire from the television set and reconnect it to the "300 OHM" screw terminals on the TV/Game Switch Box.
2. Connect the twin-lead wire from the TV/Game Switch Box to the VHF terminals or screws on your television set.

B. If your television has a "U" shaped slider or a slide switch:

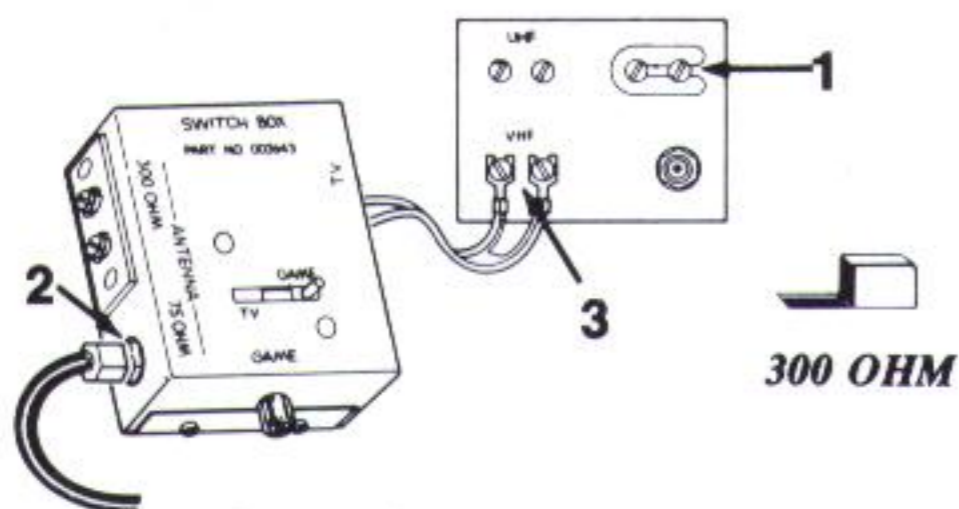

1. Move the "U" shaped slider to make connection between the two screws.

OR

Push the slide switch to the side marked "300 OHM" or "300Ω".

2. If you have a round antenna cable, Disconnect the cable from the television and plug it into the TV/Game Switch Box at the "75 OHM" connector.

OR

If you have a flat twin-lead antenna wire, Disconnect it from the television set and reconnect it to the "300 OHM" connector on the TV/Game Switch Box.

3. Connect the twin-lead wire from the TV/Game Switch Box to the VHF terminals or screws on your television set.

C. If your television has a short round cable:

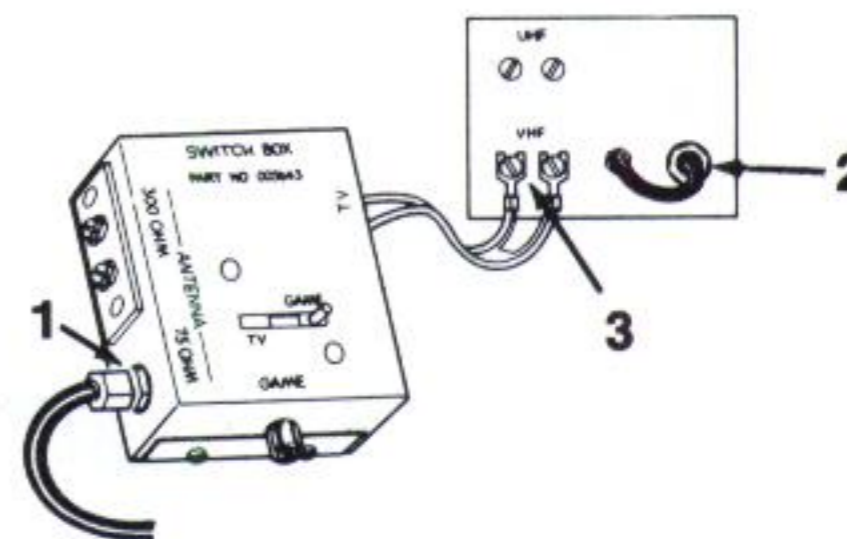

1. If you have a round antenna cable, Disconnect the long antenna cable from the television set and reconnect it to the "75 OHM" connector on the TV/Game Switch Box.

OR

If you have a flat twin-lead antenna wire, Disconnect it from the television set and reconnect it to the "300 OHM" connector on the TV/Game Switch Box.

2. Connect the TV's short loose-hanging cable to the connector next to it on your television set.
3. Connect the twin-lead wire from the TV/Game Switch Box to the VHF terminals or screws on your television set.

Plug the Game Cable from your Video Arcade console unit into the TV/Game Switch Box at the "Game" connector. The TV/Game Switch Box can be left on your television set permanently without affecting your television program reception.

The TV/Game Switch Box can be attached permanently to the back of your television set.

- Peel off the protective paper on the back of the TV/Game Switch Box.
- Press the exposed stick surface onto any clear area on the back of your television set near the antenna terminals.

Extra Switch Boxes

By attaching a TV/Game Switch Box to each television set in your home, you can easily move your Video Arcade from room to room. Extra TV/Game Switch Boxes, part number 6-99726, are available through Sears, Roebuck & Co.

Federal Communications Commission Regulations Require:

- Avoid using any longer twin-lead wire from the TV/Game Switch Box to your television than is supplied with the TV/Game Switch Box.
- Avoid connecting the twin-lead wire from the TV/Game Switch Box to any television antenna or cable-TV outlet.
- Avoid attaching loose wires to your antenna terminals when using your Video Arcade.

Any of the above may cause interference to nearby television sets and is against Federal Communications Commission (FCC) regulations.

ASSEMBLE CONSOLE

1. Attach the Controllers to be used with your Video Arcade console by plugging them into the terminals on the back of the console unit (see Fig. 2).
 - See the Game Instruction booklet packed with your Tele-Games Cartridge for the type of Controller to use.

NOTE: The Target-Fun Tele-Games Cartridge supplied with your Sears Cartridge System Video Arcade uses the Joystick Controller.

2. Insert the jack of the AC Power Supply into the back of your Video Arcade console unit (see Fig. 2)
3. Check to see that the Power Switch on the front of the Video Arcade console unit is OFF.
4. Plug the AC Power Supply into any convenient 120-volt electrical outlet.

NOTE: Using any AC Power Supply other than that designed for use with your Video Arcade can damage the console unit. Power Requirements: 9V DC, 500 ma.

5. On the TV/Game Switch Box attached to your television set's antenna terminals, move the TV/Game switch set to "Game".
6. Turn on your television.
7. Set the volume control of your television to minimum.

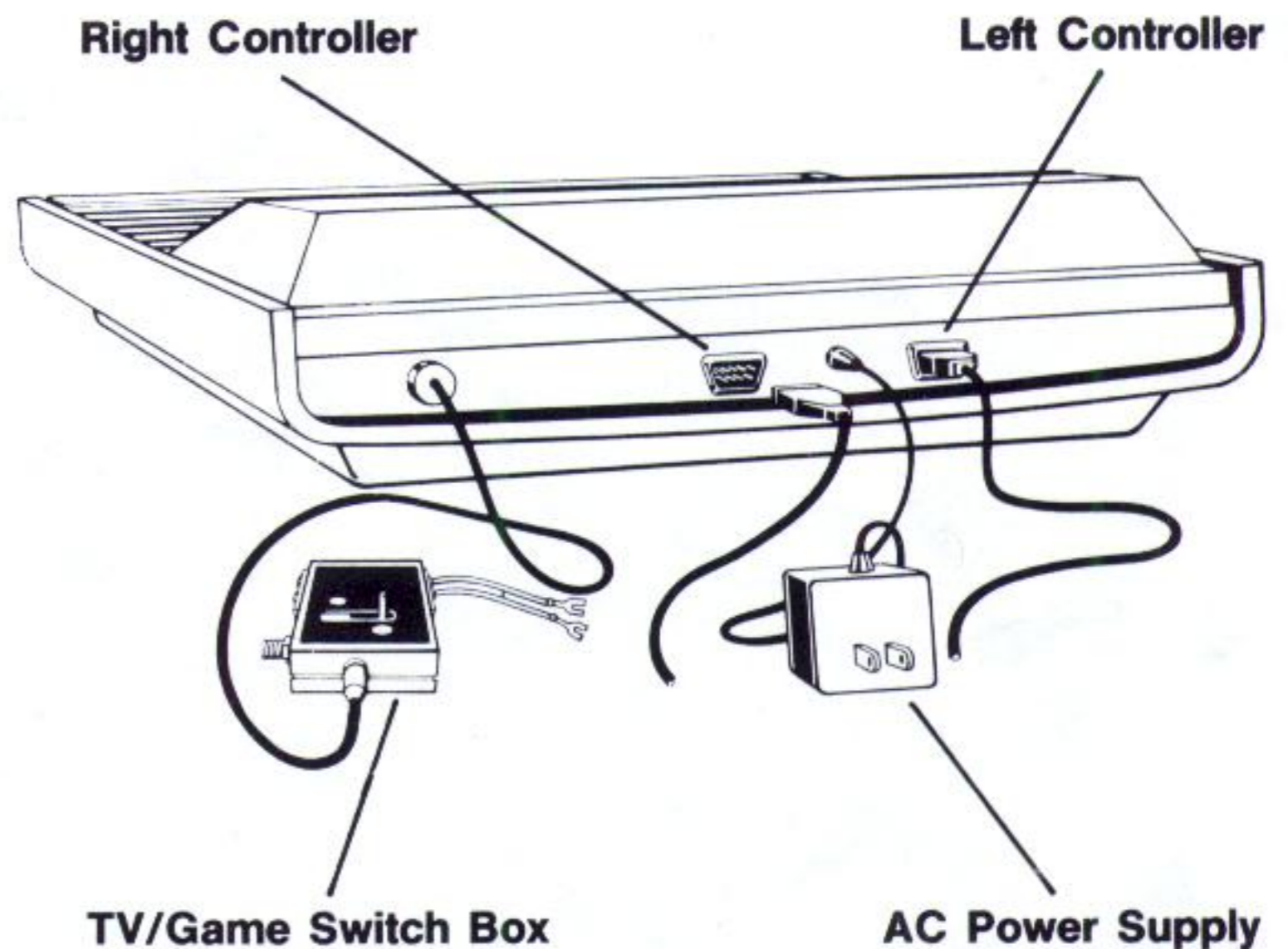

Figure 2 — Video Arcade Rear Panel

8. If your television set has an automatic fine-tuning control, turn it off.
9. Set the channel selector of your television set to channel 3.

INSERT TELE-GAMES CARTRIDGE

1. Check to see that the Power Switch on the Video Arcade console unit is OFF.

IMPORTANT: To prolong the life of your Sears Cartridge Tele-Games System Video Arcade and protect the electronic components, the Video Arcade console unit should be OFF when inserting or removing a Tele-Games Cartridge.

2. Hold the Tele-Games Cartridge so the name on the end is towards you and reads right side up.
3. Insert the Tele-Games Cartridge CAREFULLY into the slot in the center of the Video Arcade console unit switch panel (see Fig. 3). Be sure the cartridge is firmly seated, but do NOT TRY TO FORCE IT.

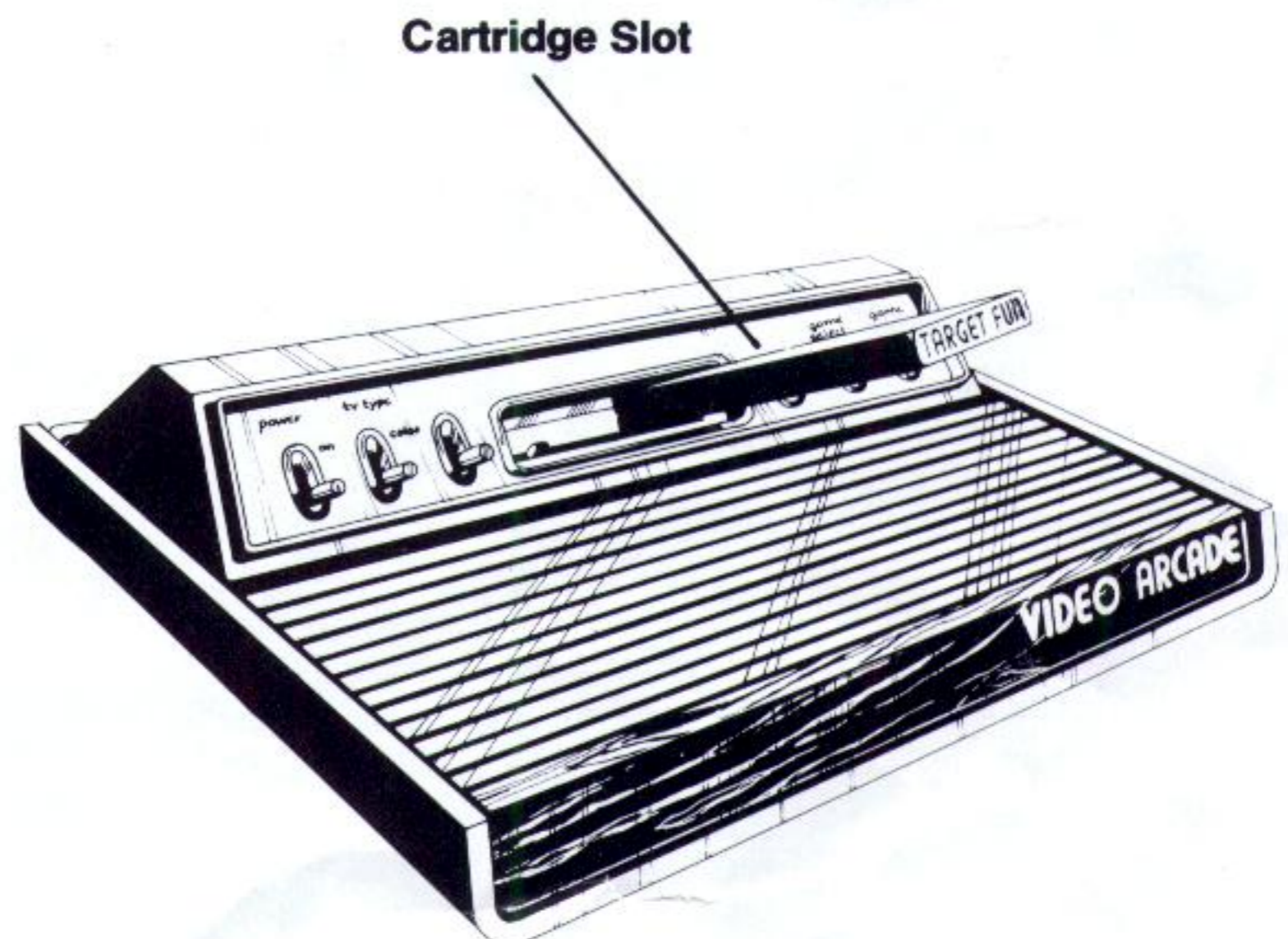

Fig. 3 — Inserting Tele-Games Cartridge into Video Arcade Console Unit.

When removing the Tele-Games Cartridge, pull it straight out of the Video Arcade console. Check to see that the power switch on the Console is OFF.

TO START PLAY

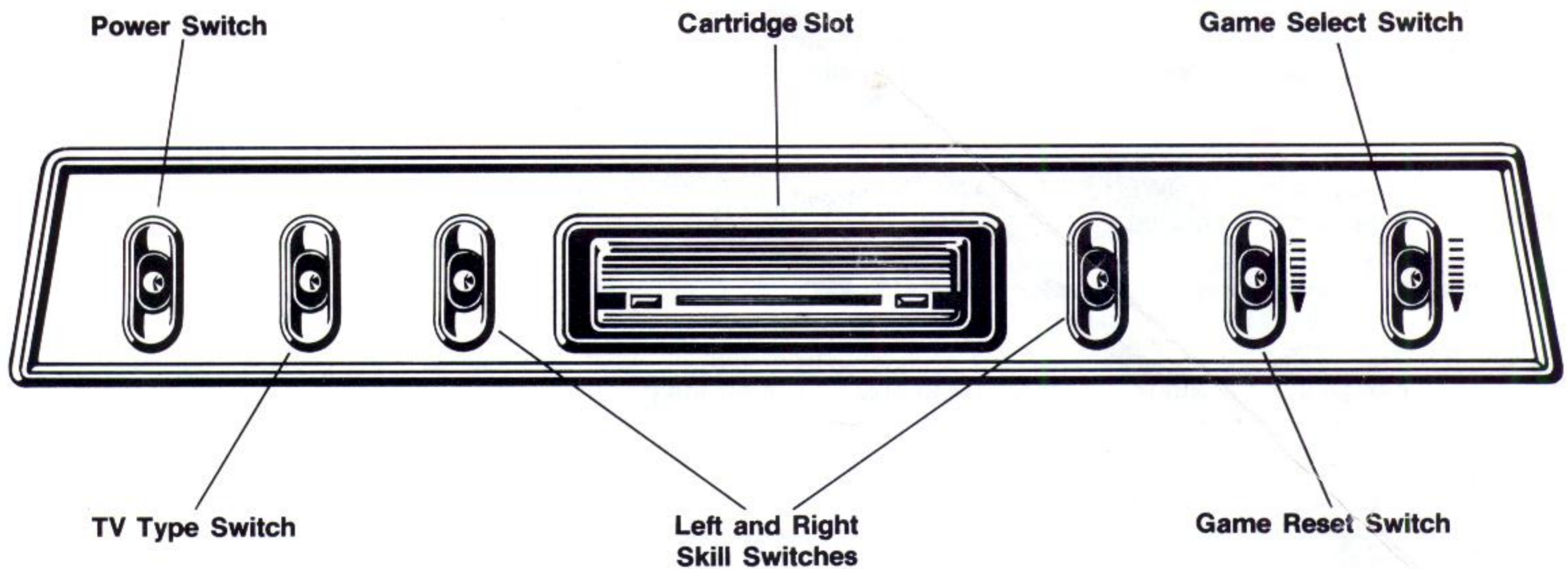

Fig. 4 — Video Arcade Console Switch Panel

1. If your Video Arcade is attached to a color television, slide the TV Type switch to the "Color" position (see Fig. 4). This will allow you to play the games in vivid color.

If your television set is black and white, slide the TV TYPE switch to "B&W". The Video Arcade console will adjust the contrast of your television so you can get full enjoyment of the games on your black and white television.

2. Slide the POWER switch to "ON". A game playfield will appear on your television screen.

IMPORTANT: If no playfield appears, which can happen if you have inserted the Tele-Games Cartridge while the Video Arcade is turned ON, slide the Power Switch to OFF and then back to ON. To prolong the life of your Sears Cartridge Tele-Games System Video Arcade, the unit should be OFF when inserting or removing a Tele-Games Cartridge.

3. Adjust the volume control of your television set to a comfortable level. The game sounds will be coming from your television speaker.
4. Using the Fine-Tuning control on your television set, adjust your picture to get the best image. This is especially important if you don't normally use channel 3.
5. Depress the SELECT Switch on the Video Arcade (see Fig. 4). A number will appear on the upper left corner of your television screen. This number corresponds with the Game Number in the Game Instruction booklet supplied with your Tele-Games Cartridge. When the number of the game you wish to play appears, release the SELECT Switch.

6. Depress the RESET Switch (see Fig. 4). Game action will begin. By depressing the RESET Switch anytime during the game, the score will reset to 0-0.

7. The SKILL Switches (Left and Right) change the game action (See Fig. 4). "EXPERT" position is generally more difficult than "NOVICE" position. As a handicap for more experienced players, one side can be played in "EXPERT" and the other side in "NOVICE". Or, both sides can be played in the same position. Details of the Skill Option are explained in the Game Instruction booklet supplied with your Tele-Games Cartridge.

To Return Your Television Set to Regular Programs:

1. Slide the POWER Switch on the Video Arcade console unit to OFF.
 2. On the TV/Game Switch Box attached to the back of your television set, slide the switch to "TV".
 3. If your television has automatic fine-tuning, turn it ON.
-

HOW TO CARE FOR YOUR VIDEO ARCADE

Your Sears Cartridge Tele-Games System Video Arcade™ should bring many years of enjoyment. In order to keep your Video Arcade in good working condition, please remember the following points:

1. Always turn the POWER Switch on the Video Arcade console unit "OFF" before inserting or removing the Tele-Games Cartridge.
2. Don't try to force the Tele-Games Cartridge into the console slot.
3. Your Tele-Games Cartridges are protected from normal wear and tear as they are fully enclosed. However, care should be taken not to spill liquids on them.
4. Don't pour liquids into the Cartridge Slot of the Video Arcade console unit.
5. Lifting the Video Arcade console unit or the Controllers by the connecting wires can bend or crimp them, breaking the internal insulation of the wire.
6. Care should be taken not to drop the Video Arcade console unit, Controllers, or Tele-Game Cartridges on any hard surface.
7. Do not expose the Video Arcade console unit, Controllers, or Tele-Games Cartridges to excessive or extreme heat.
8. Remember to turn the Video Arcade console unit OFF when not in use.
9. Use of any AC Power Supply other than that designed for use with your Sears Cartridge Tele-Games System Video Arcade™ can damage the electronic parts of the system.
10. Clean the exterior parts with a soft, slightly damp cloth.

NOTE: Your Sears Cartridge Tele-Games System Video Arcade™ is engineered to help eliminate phosphor memory of the playfield and score digits. We suggest, however, to further protect your TV:

- When playing the games, turn the contrast of your television set down.
 - Turn the Video Arcade console unit OFF when not in use.
-

TROUBLE SHOOTING CHECKLIST

| SYMPTOM | PROBABLE CAUSE AND REMEDY |
|---|--|
| No playfield image on television screen or whitish-grey screen | <ul style="list-style-type: none"> ● Switch Box -set at "TV", change to "GAME". ● Game Cable not properly plugged into Switch Box. ● Twin-lead wire not properly plugged into Switch Box. ● Video Arcade Console unit Power Switch not turned ON. ● Tele-Games Cartridge inserted into Video Arcade Console unit while Power Switch was ON. Slide Power Switch to OFF and back to ON. ● A particularly strong television station may be broadcasting on channel 3 in your area (or on cable TV). Remove the antenna wire or cable from the ANTENNA connection on the TV/Game Switch Box. |
| No regular Television programs | <ul style="list-style-type: none"> ● TV/Games Switch Box set at "Game". Change to "TV". ● Twin-lead wire not properly attached to VHF antenna terminals on rear of television. ● Antenna wire not properly attached at "300 OHM" screws on TV/Game Switch Box. |
| Playfield fuzzy, like weak television signal | <ul style="list-style-type: none"> ● Poor connections at antenna terminals of television set or TV/Game Switch Box. ● Television set not fine-tuned for best picture. Adjust television set fine-tuning control. ● A particularly strong television station may be broadcasting on channel 3 in your area (or on cable TV). Remove the antenna wire or cable from the ANTENNA connection on the TV/Game Switch Box. |
| Playfield unsharp, unsteady or no color | <ul style="list-style-type: none"> ● TV TYPE Switch on Video Arcade Console set at "B&W" position. Move to "COLOR". ● Television set not fine-tuned for best picture. Adjust television set fine-tuning, color or tint controls. ● A particularly strong television setation may be broadcasting on channel 3 in your area (or on cable TV). Remove the antenna wire or cable from the ANTENNA connection on the TV/Game Switch Box. |
| Playfield unsharp, unsteady or unable to tell differences between playing pieces and/or playfield (B&W TV). | <ul style="list-style-type: none"> ● TV TYPE Switch on Video Arcade Console set at "Color" position. Move to "B&W". ● A particularly strong television station may be broadcasting on channel 3 in your area (or on cable TV). Remove the antenna wire or cable from the ANTENNA connection on the TV/Game Switch Box. |
| Sound buzzes or is distorted | <ul style="list-style-type: none"> ● Television set not fine-tuned. Adjust television set fine-tuning controls until both picture and sound are clear. ● A particularly strong television station may be broadcasting on channel 3 in your area (or on cable TV). Remove the antenna wire or cable from the ANTENNA connection on the TV/Game Switch Box. |
| No game sounds | <ul style="list-style-type: none"> ● Television set volume not turned up. Adjust television set volume to desired level. |
| Right or left side of playfield not visible near side of television picture tube. | <ul style="list-style-type: none"> ● Adjust horizontal hold control on your television set slightly. |