

An Action
Role-Playing Movie
ARPM

Iron Angel of The Apocalypse™

鉄人

TETSUJIN

READ BEFORE USING YOUR 3DO INTERACTIVE MULTIPLAYER™ SYSTEM

EPILEPSY WARNING

A very small percentage of individuals may experience epileptic seizures when exposed to certain light patterns or flashing lights.

Exposure to certain patterns or backgrounds on a television screen or while playing video games may induce an epileptic seizure in these individuals. Certain conditions may induce previously undetected epileptic symptoms even in persons who have no history of prior seizures or epilepsy. If you, or anyone in your family, has an epileptic condition, consult your physician prior to playing. If you experience any of the following symptoms while playing this video game—dizziness, altered vision, eye or muscle twitches, loss of awareness, disorientation, any involuntary movement, or convulsions—**IMMEDIATELY** discontinue use and consult your physician before resuming play.

We thank you for
purchasing the action
role-playing movie
Tetsujin.

Prior to commencing
play make sure that
the following items are
in your package.
Also, read the accompanying
instructions
carefully before playing.

- CD-ROM
- Instruction Pamphlet
- User Registration Card

*The information contained
in this instruction pamphlet is
current as of November 1994.*

*The information contained
herein is subject to change
without prior notice.*



TETSUJIN

**Iron Angel
of
The Apocalypse**

Table of Contents

Starting Up the Game	p.4
How to Operate the Game	p.8
How to Read the Screens	p.12
An Introduction to the Characters	p.18
An Introduction to Tetsujin's Weaponry	p.28
Assault Hints	p.30
Credits	p.34
SYNERGY, Inc Limited Warranty	p.36



How does it feel to be alive again?
I'm giving you the chance to be Tetsujin

Humans should've risen to a higher plane by now
But the weakness of organic systems held us back

Now is the time to free the mind and create Tetsujin
You can be proud of yourself
As Tetsujin you'll live forever

I want to see you with my own eyes
Come to me
Come to my laboratory up on the top floor

If anything tries to stop you, blow it away
Miss...and it's all over

Assimilation is under way
There's no stopping it



Starting Up the Game

Turn on the power of your 3DO™ Interactive Multiplayer and verify that the power lamp has lit up. Press the open/close button, place the CD on the disk tray and then again press the open/close button. The 3DO logo and the *Tetsujin* title logo will appear and a demo display will begin to unreel.

Interrupt the demo display by pushing the P-button on the control pad.

See 'How to Operate the Game' (pages 8-11) for explanations of control buttons.



Demo display

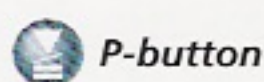

Opening sequence

1. Start Up

When playing *Tetsujin* for the first time or when having not yet saved data, the opening sequence will automatically begin and you will advance to stage 1.

2. Main Menu

If you have saved data, the main menu will be displayed. Select with the direction pad and load by pushing the A-button. If the X-button is pushed you will start from stage 1.

● NEW GAME

Using the direction pad, select this item from Main Menu if you wish to begin *Tetsujin* at the



Main Menu



Opening sequence

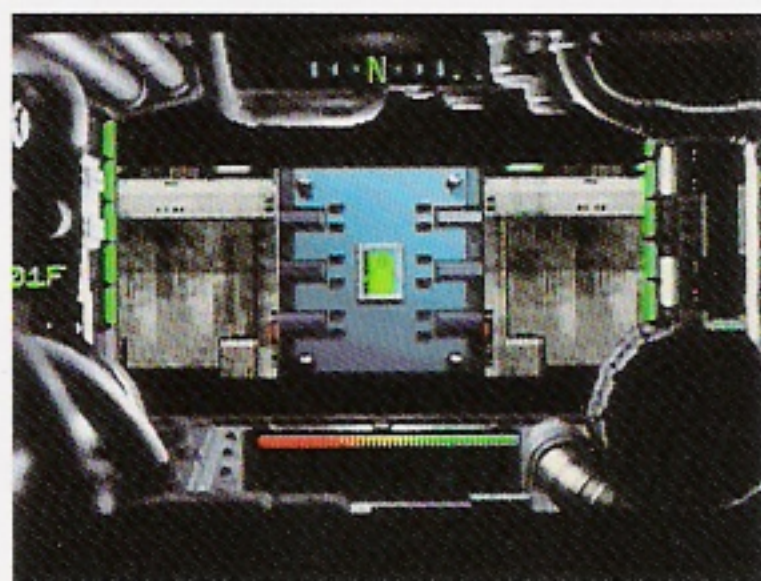

Stage 1

beginning from stage 1. After the opening sequence, stage 1 will start up. If you press the X-button you will skip over the opening sequence.

● **LOAD DATA**

Select this item from Main Menu if you wish to start from a position that you have previously saved. Adjust the pointer to LOAD DATA and push the A-button. A list of saved data will be displayed. The pointer will indicate the data that has been saved most recently. With the direction pad select the data that you wish to load and then press the A-button. If you wish to

cancel, press the B-button. You will return to Main Menu.

If you press the X-button, you will start from stage 1.

● **DELETE DATA**

Select this item if you wish to delete all the saved data that is listed in the LOAD DATA display. If you press the A-button, you will be asked if you really want to delete everything. If you press the A-button once more, all the items from DATA 1 to DATA 4 will be deleted.

If you press the X-button, you will start from stage 1.



Main Menu



Main Menu



List of saved data



Really want to delete?



Loading data

Starting Up the Game

3. Saving Data

Data can be saved at the Supply Room in each stage. Nowhere else is it possible to save data. Also, when you enter a Supply Room, you will be able to replenish expended ammunition and recharge shield energy. There is at least one Supply Room on each floor.

● SAVE DATA

When Saving Data for the First Time

If there is no other saved data, all you need do to save is, with the pointer at SAVE DATA in the Save Menu, press the A-button. Blank settings for the data-save files DATA 1 through DATA 4 will

be indicated in each instance by XXX. If any of the files is selected with the direction key and A-button pressed, your present position will be saved. You may then select EXIT or you may return to your position by pressing the B-button.

When Saving Multiple Data

If data is already in the data-save file you have selected, you will be asked if you want to replace the old data with the new. If you wish to replace the data, press the A-button, but if you wish to designate a different data-save file, press the B-button to cancel.

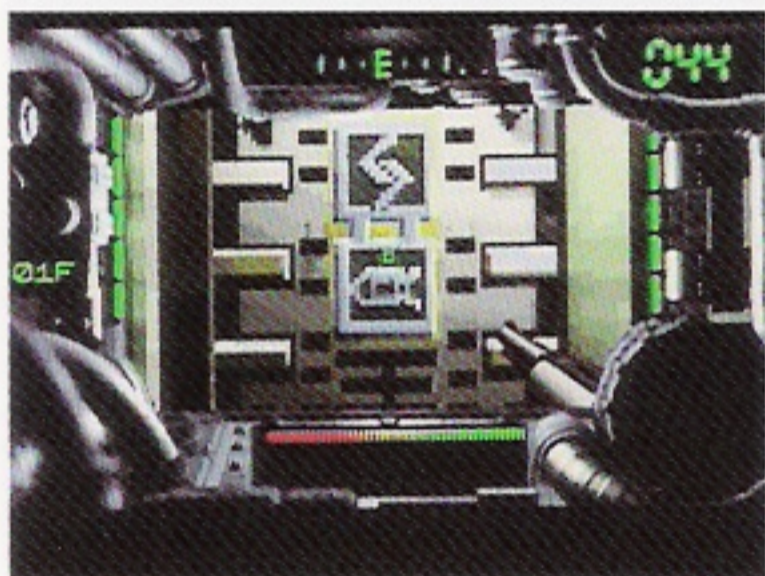

Supply Room door



Recharge movie



Save Menu

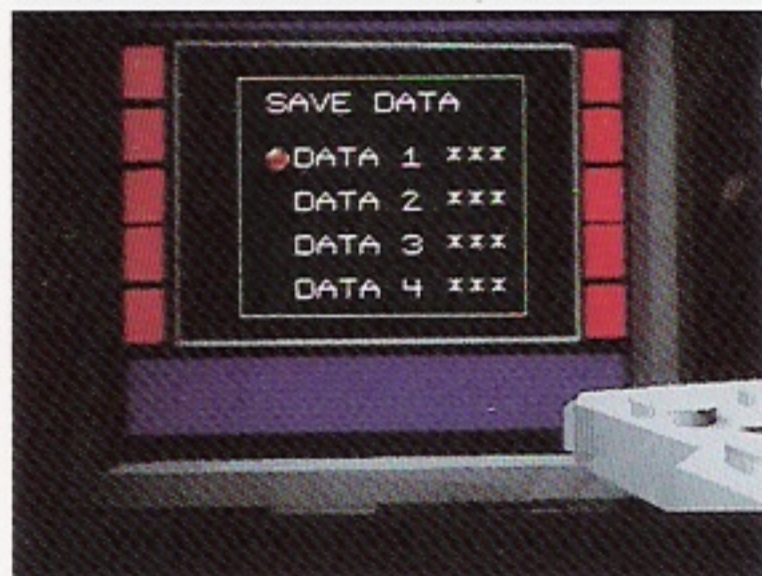

Save Menu



Select a data item and save by pressing the A-button

On the Backup Memory Control Tool

Tetsujin data saved at a Supply Room is stored as Backup Memory in static RAM of your Interactive Multiplayer. The data is retained in Backup Memory even when the power is switched off. However, as Backup Memory contains other data besides that of *Tetsujin*, it may become full, making it impossible to store *Tetsujin* data. If this should be the case, activate the Backup Memory Control Tool and delete data of software other than *Tetsujin*.

1. If Backup Memory is full, a message will be displayed when you activate *Tetsujin*. (Fig. 1) If you select DELETE,



From save Menu to a List of saved data



Replace data?

the DELETE GAME DATA display will appear. (Fig. 2)

If you select START, Tetsujin will start up without the capacity to save data.

2. Stored-data file names will appear on the lefthand side of the DELETE GAME DATA display. Using the direction pad, select data you wish to delete. The color of selected files will be reversed.

3. When you have designated data for deletion, select DELETE with the direction pad. If you then press the A-button, the designated data files will be deleted and Tetsujin will start up.

If you select CANCEL, the files will not be deleted.

Repeat steps 2 and 3 until Backup Memory is able to store Tetsujin data.

SRAM IS FULL
CANNOT SAVE NEW DATA
PLEASE DELETE OTHER DATA
A: DELETE B: START

Fig. 1
The Tetsujin data-storage file is SY-TETSU-1J.

DELETE GAME DATA
/NVRAM
CHOOSE FILE: CANCEL
NEXT SAVER
Stored-data file names
DELETE

Fig. 2

How to Operate the Game

Tetsujin can be controlled by operating the buttons in the following manner.

A-Button

1. OK: Used for executing selected menu items or for okaying items on the save menu and other displays.

2. SHOOT: Used for firing weapons held in the right hand. When a set number of rounds hit enemy motoids, they blow up.

B-Button

1. CANCEL: Used for cancelling

2. TAKE: Used for opening doors, grasping things, or in some other way using the hands.

C-Button

TURBO: After obtaining a turbo booster, this switch may be used to turn the booster on. A lamp on the left of the canopy display will continue to blink throughout turbo activation.

● Names of the Devices on the Control Pad

R-Shift

Control Port

L-Shift

Direction Pad

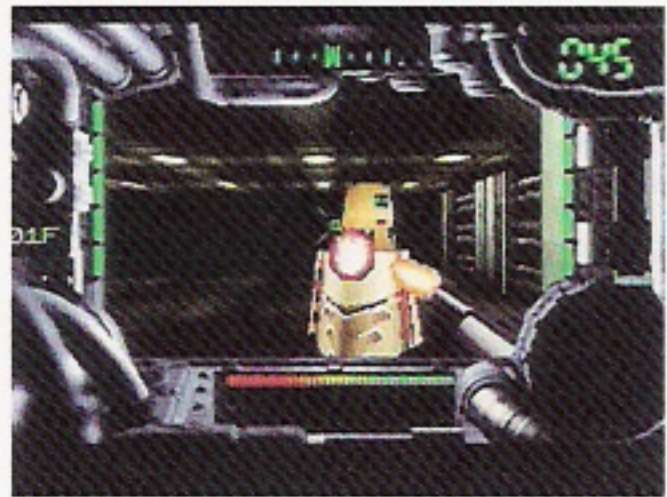
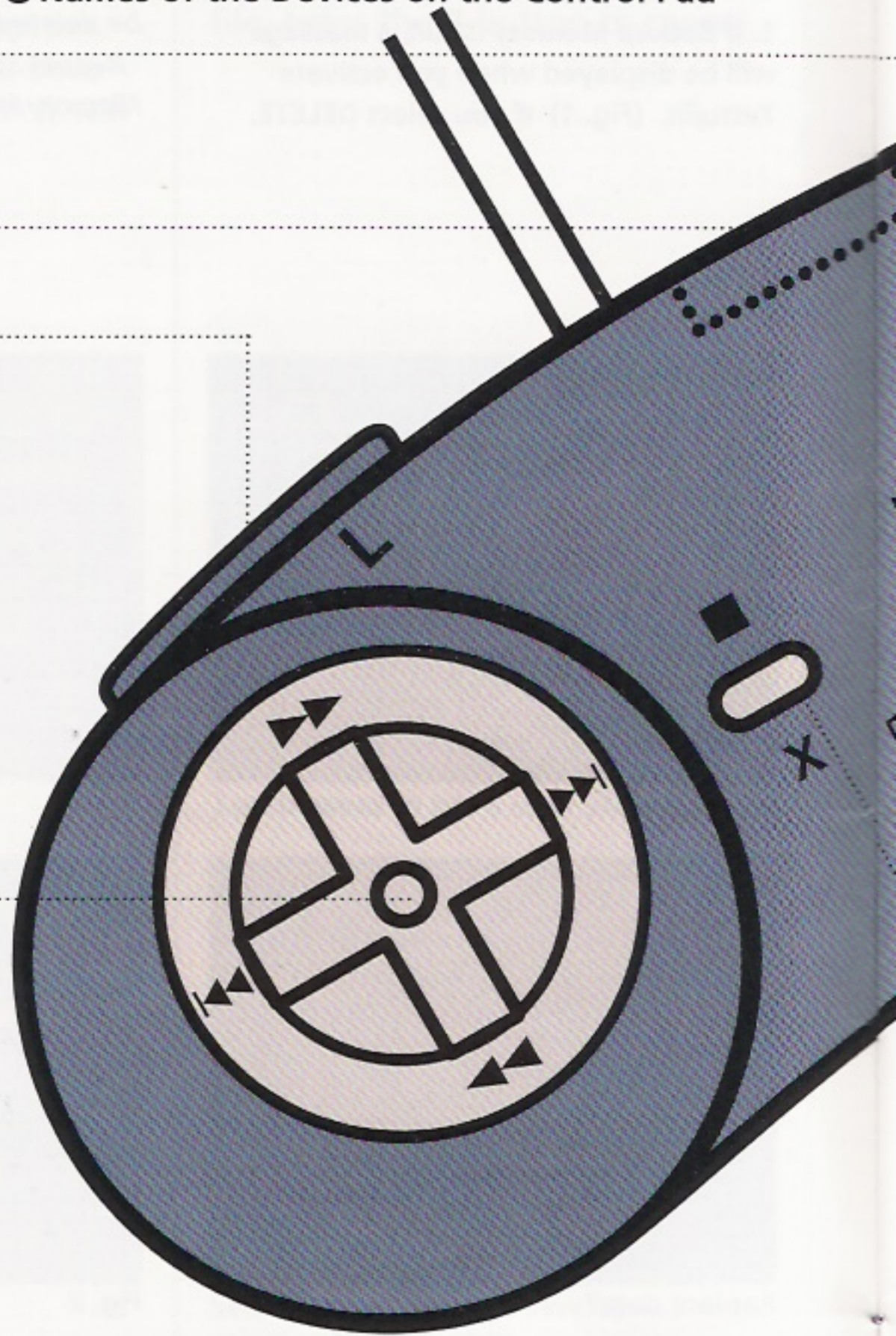

Firing a weapon

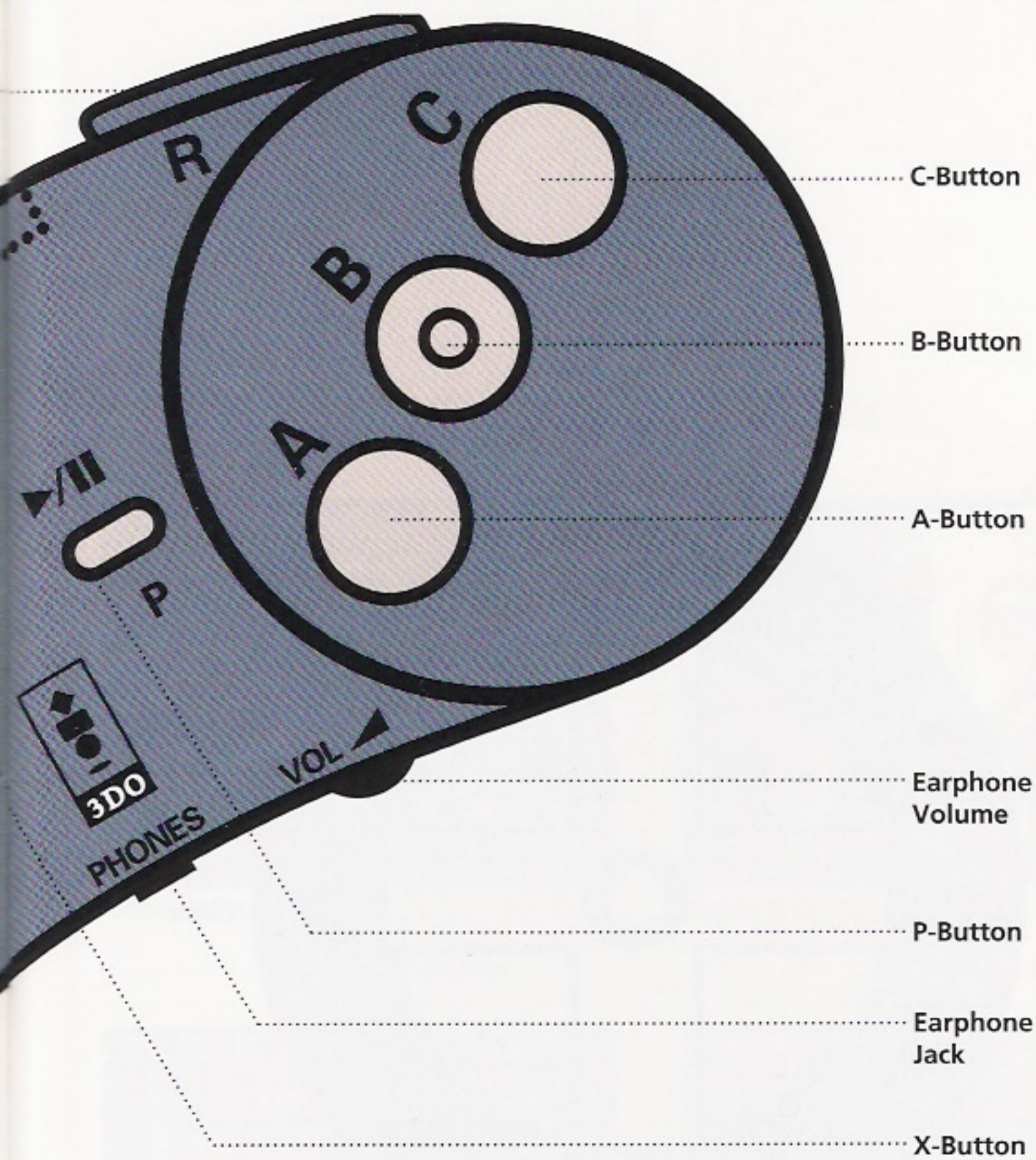

Extinction by explosion

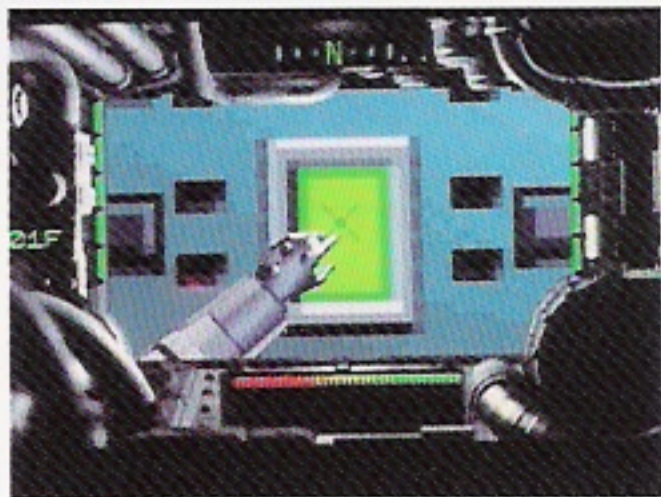

Opening a door

How to Operate the Game

L-Shift, R-Shift and the Direction Pad

1. **SELECTING MENU ITEMS:** By pressing Up or Down with the direction pad, the pointer will shift.

2. **MOBILITY:** These devices are also used when you move about each stage of Tetsujin.

If from Basic Commands CONFIGURATION is selected, the functions of L- and R-shift can be changed. (See page17)

When the direction pad is set as in the diagram below, pressing L-shift or R-shift will enable you to move directly to the left or to the right.

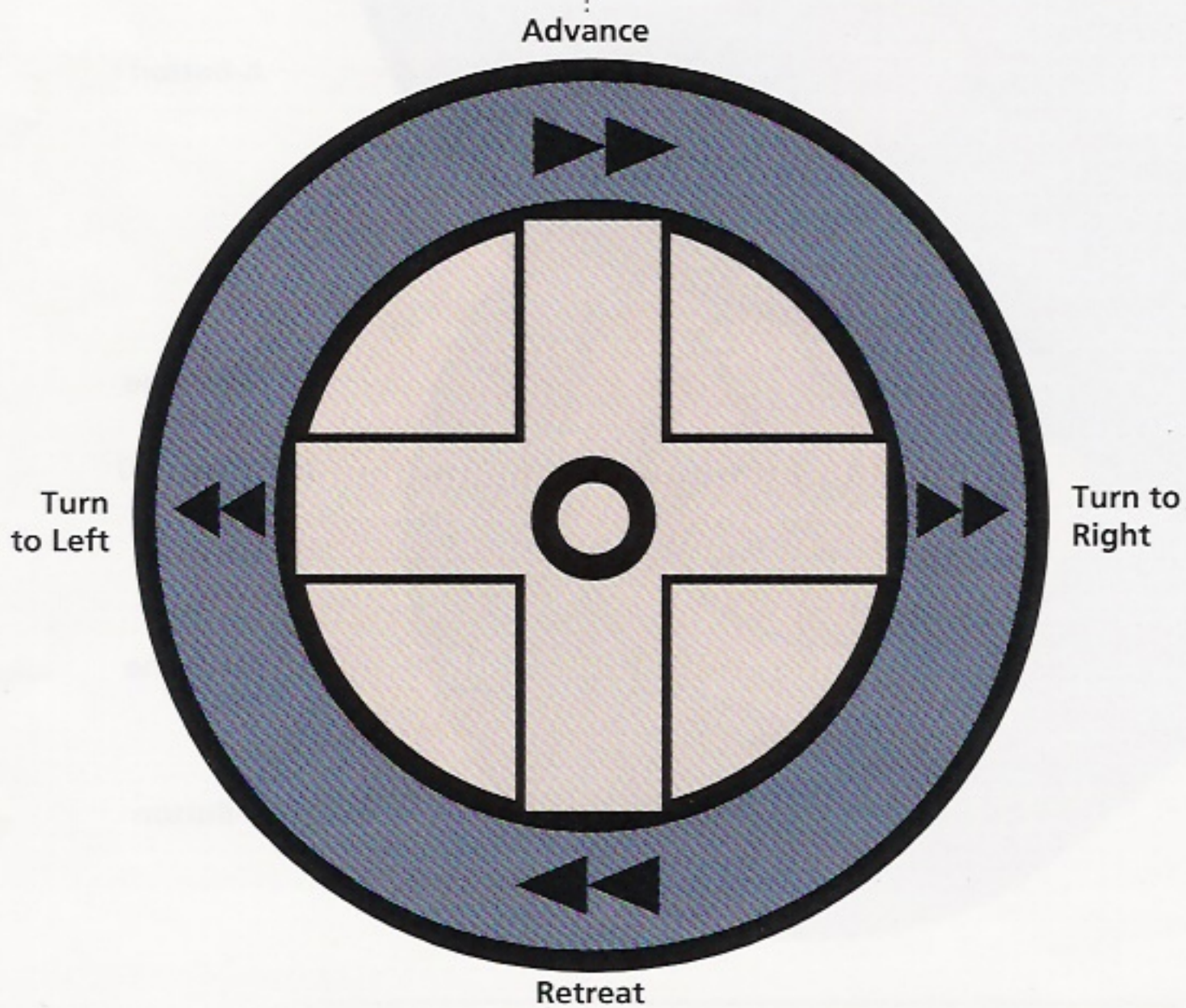

P-Button

1. BASIC COMMANDS: If the P-button is pressed during the Canopy Screen, the Basic Commands will be displayed.

2. SKIP THE MOVIE SCREEN: If the P-button is pressed while a movie is in progress, you will skip over that movie to the next stage.

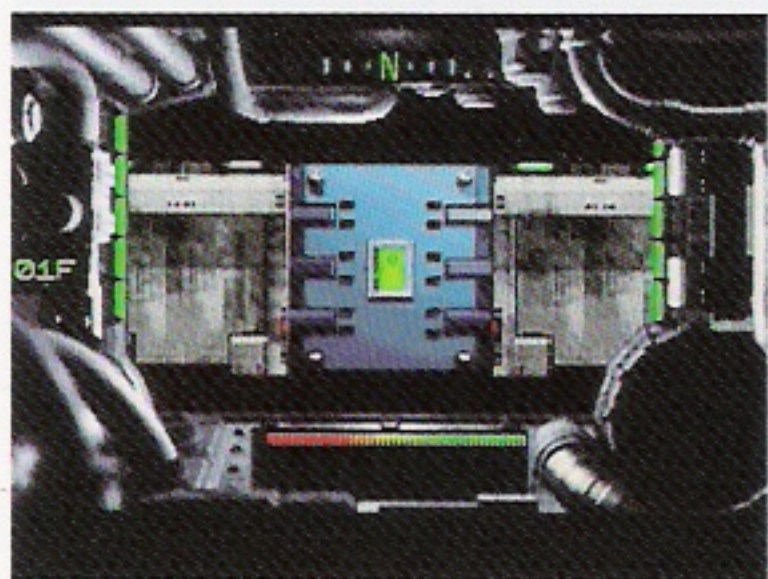

Canopy Screen

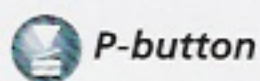

Basic Commands are displayed

X-Button

START STAGE 1: If the X-button is pressed while Main Memory or its items are displayed, you will start up from stage 1.



Movie Screen

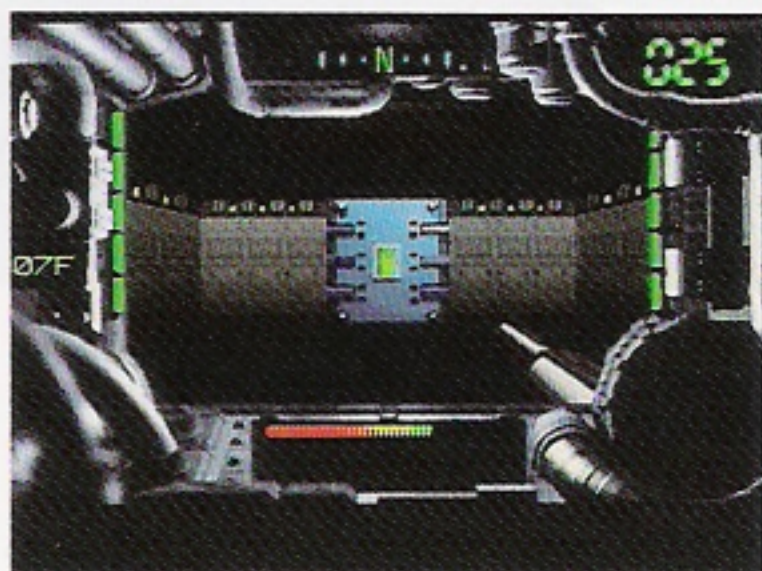
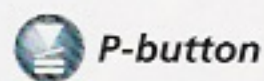

Next stage

How to Read the Screens

1. Canopy Screen

This is the screen that appears when you move about an action stage. It is from this perspective that you destroy enemy motoids and get hold of various pieces of gear. However, the elements of the Canopy Screen are not all in your hands at the beginning of play. Some items can be picked up as you pass through the action stages.

- 1** GYROCOMPASS: Shows in what direction you are moving.
- 2** ROUND COUNTER: Shows how many rounds you have left at any moment. A warning light blinks when you reach zero.
- 3** TURBO METER: Displays remaining units of turbo power.

A warning light blinks when you reach zero.

- 4** RADAR: You can track the approach of motoids.
- 5** SHIELD METER: Shows remaining units of shield energy. At the outset you have only 1 unit. A warning light blinks when you reach zero.
- 6** AIMING DEVICE: You train it on motoids that have appeared, using it to control the direction of your advance and to fire your weapons.
- 7** FLOOR DISPLAY: Shows what floor you're on.
- 8** TURBO ACTIVATION LAMP: Blinks when the turbo booster is in use.

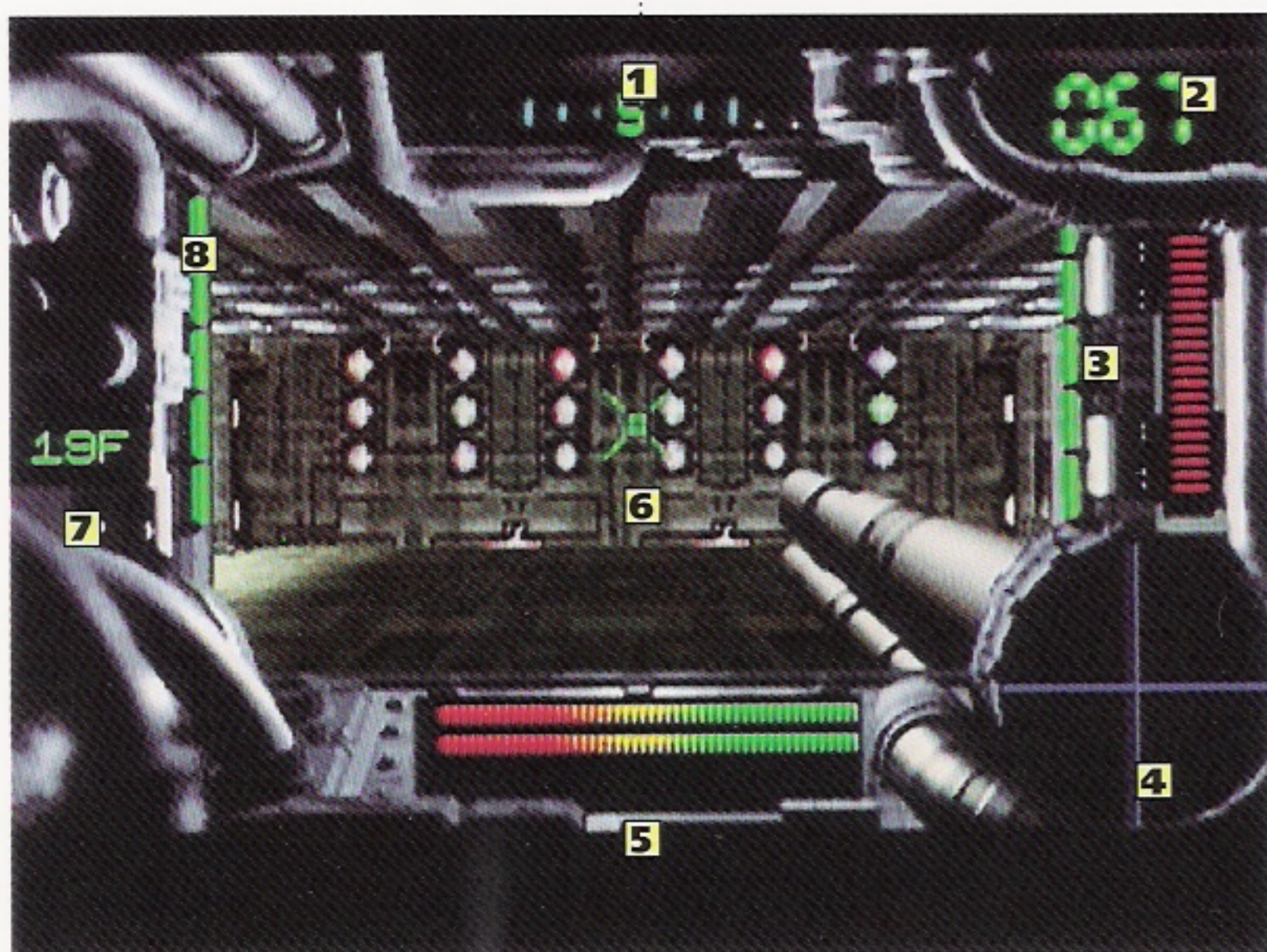

2. Movie Screen

Movies of set lengths start up automatically. If you press your control pad's P-button while a movie is in progress, you will skip over it to the next stage. With the movie screen you cannot use button A, B, or C, nor can you use L- and R-shift.

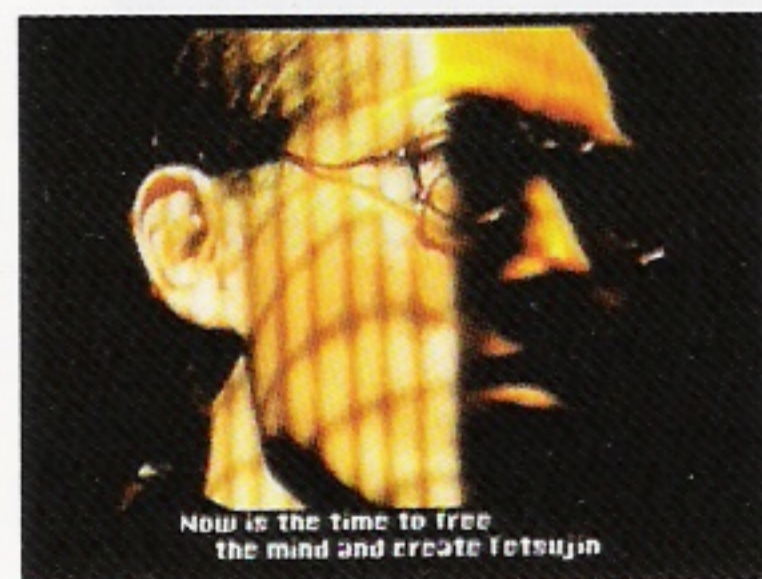

3. Game's Over

If you have taken damage from a motoid attack and shield energy has dropped to zero and, on top of that, you receive further attacks, the game will end. After first going black the screen will display GAME OVER and then a menu.

If you select CONTINUE and have previously saved data, the list of saved data will appear and you can resume play from the last saved position. If you have not saved any data, you will automatically begin from the opening sequence leading to stage 1. If you select RESTART, you will begin from the *Tetsujin* title logo.



Game's over



Select either CONTINUE or RESTART

How to Read the Screens

4. Basic Commands

If you press your control pad's P-button when the canopy screen is displayed, the basic commands will appear. Select a command with the direction pad and enter it by pressing the A-button.

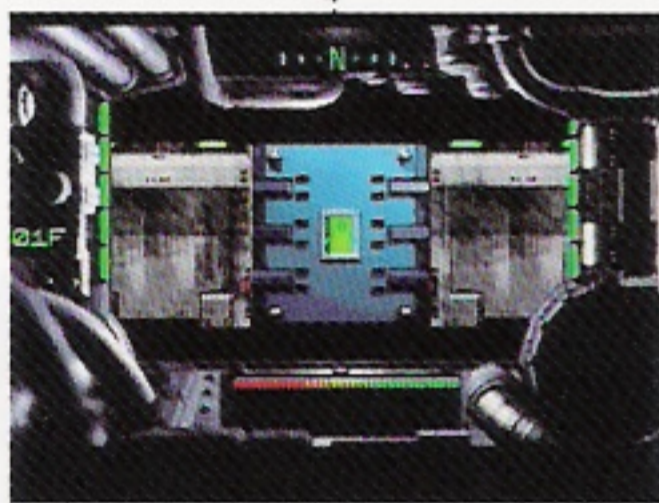

Canopy Screen

 *P-button is pressed*



Basic commands are displayed

① FLOOR MAP

One of the items located somewhere on each level is floor map data. Once you have obtained the data, you can use this command to see the layout of the floor.

- 1: Elevator
- 2: Floor number (Using L- and R-shift on your control pad you can go down or up)
- 3: Position of Tetsujin
- 4: Supply room
- 5: Cursor coordinates (The first two digits are the X coordinate and the last two digits the Y coordinate)
- 6: Direction you face
- 7: Cursor



Get floor map data



Select FLOOR MAP for display

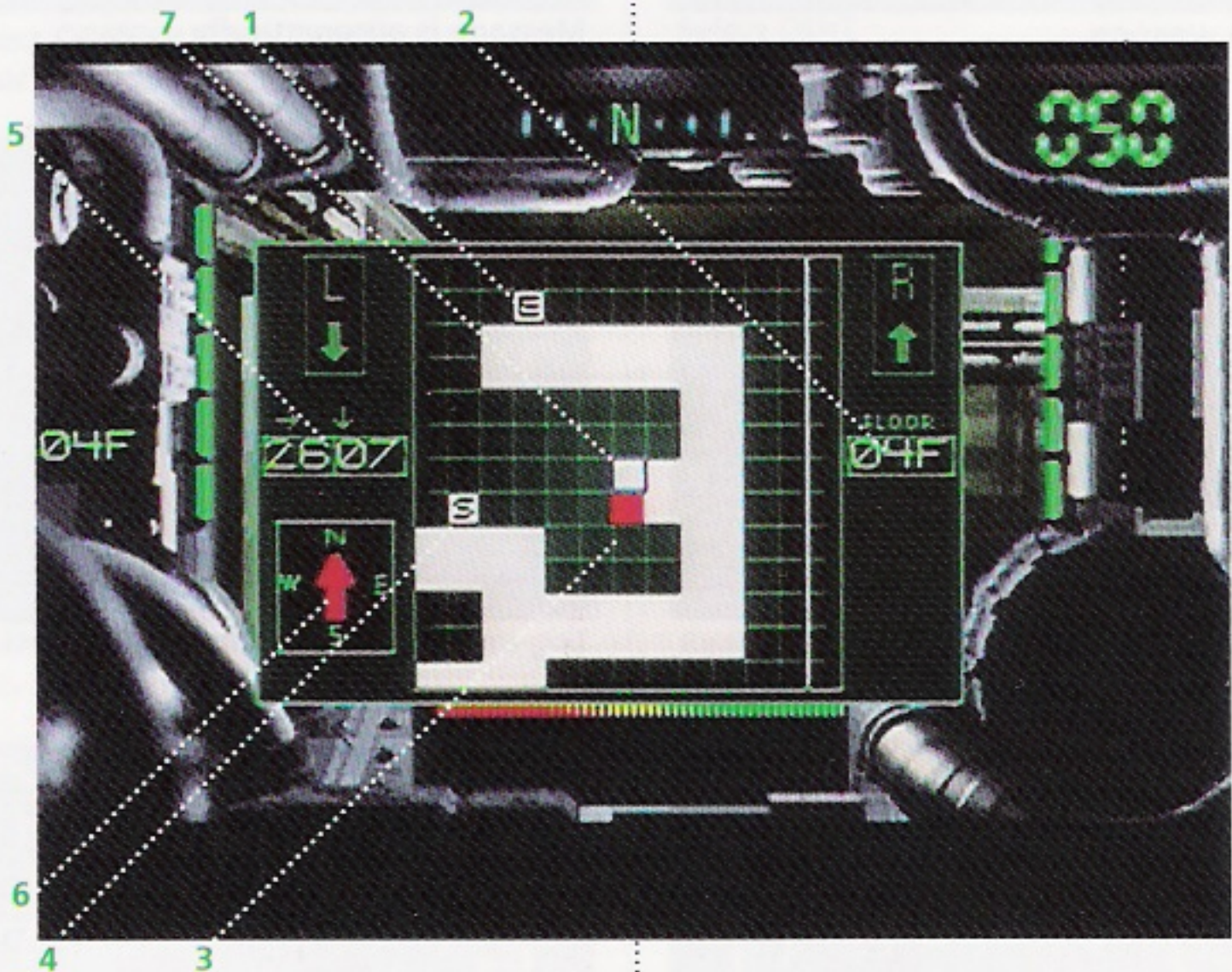

How to Read the Screens

② WEAPON CHANGE

When first beginning a NEW GAME, Tetsujin is unarmed. The initial weapon obtained is the RUNT GUN, which has been left somewhere on this floor. When you have picked it up in Tetsujin's hand, use this command to activate it.

Weapons cannot be used to assault motoids simply by taking them in your hand. Each must first be armed by selecting the WEAPON CHANGE command.

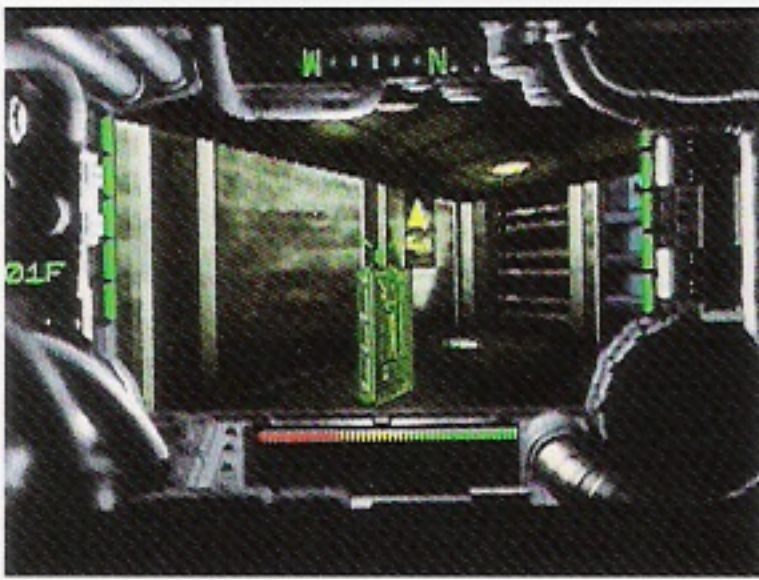

Get a weapon



Select WEAPON CHANGE



Select RUNT GUN and arm it

③ MESSAGE

During a stage you may receive a message. The log-in display lamp will blink and the message be transmitted. When it ends, the canopy screen will return.

A message that has already been received can be heard again by passing the same point on a floor. If you wish a communication to be repeated, select MESSAGE from basic commands.

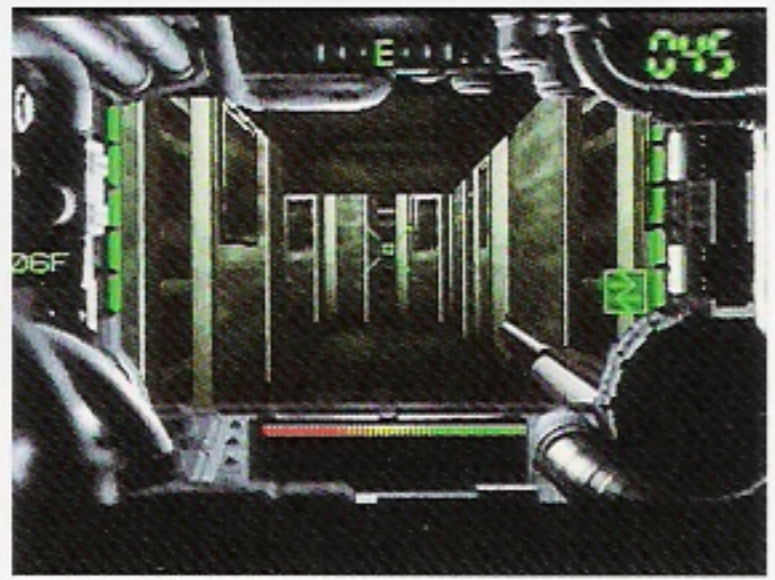

Message is automatically received



Log-in display lamp blinks on and off

④ CONFIGURATION

The functions of control pad buttons can be changed.

⑤ QUIT

Select to terminate game. If you press the A-button, you will be asked if you really want to quit. If you press the A-button again you will terminate and return to the demo screen.

Before quitting be sure to save position data if you wish later to resume from where you left off.

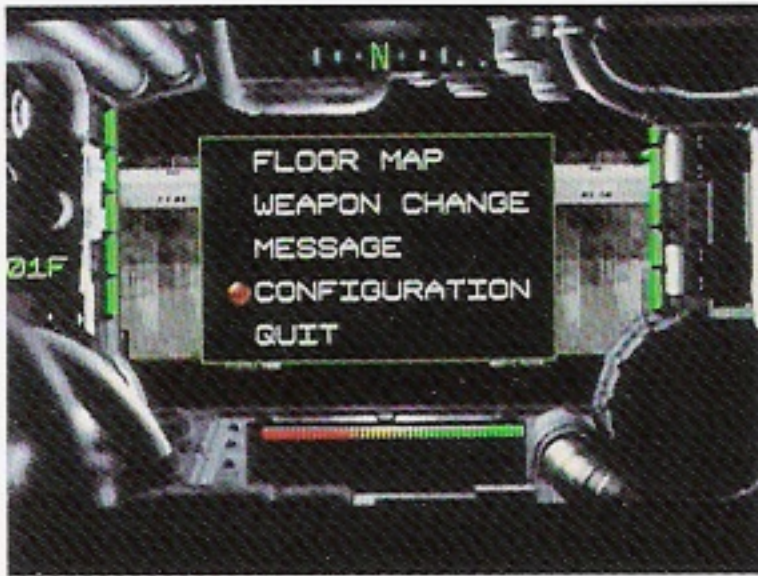

Select CONFIGURATION from basic commands

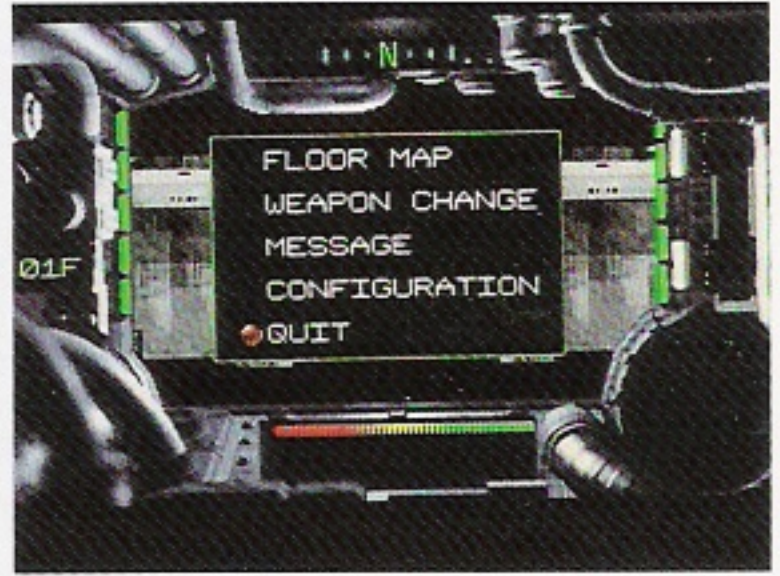

Select QUIT

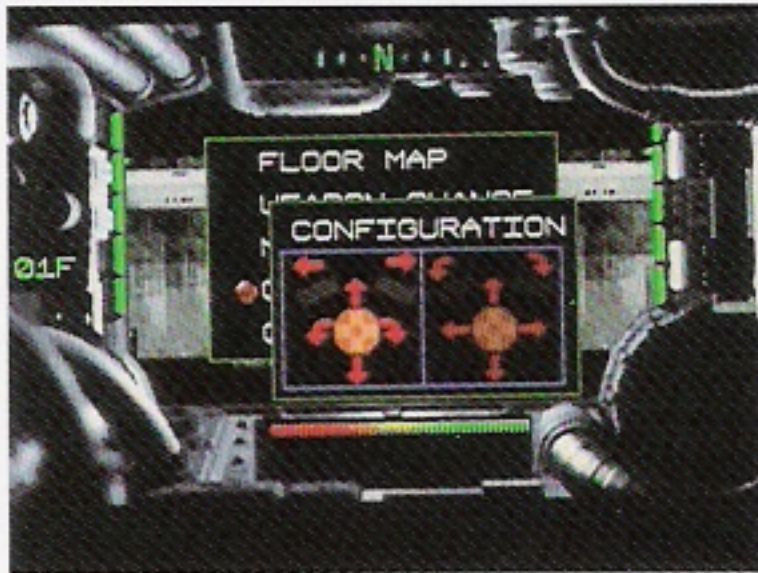

Change functions of direction key or L- and R-shift



Really want to quit?



Customize buttons A, B or C

An Introduction to the Characters

● Tetsujin, Iron Angel of the Apocalypse

The ultimate killing machine. Developed by a mad-genius scientist, who uses a special technology to bond metal alloy to human muscle and bone. Tetsujin possesses tremendous destructive power which increases exponentially when

he's equipped with his arsenal of weapons. Ordinary firearms are ineffective against him.

If the mad genius isn't stopped, humankind will be annihilated. Something must be done before Tetsujin's assimilation process is complete.

Everything depends on you!

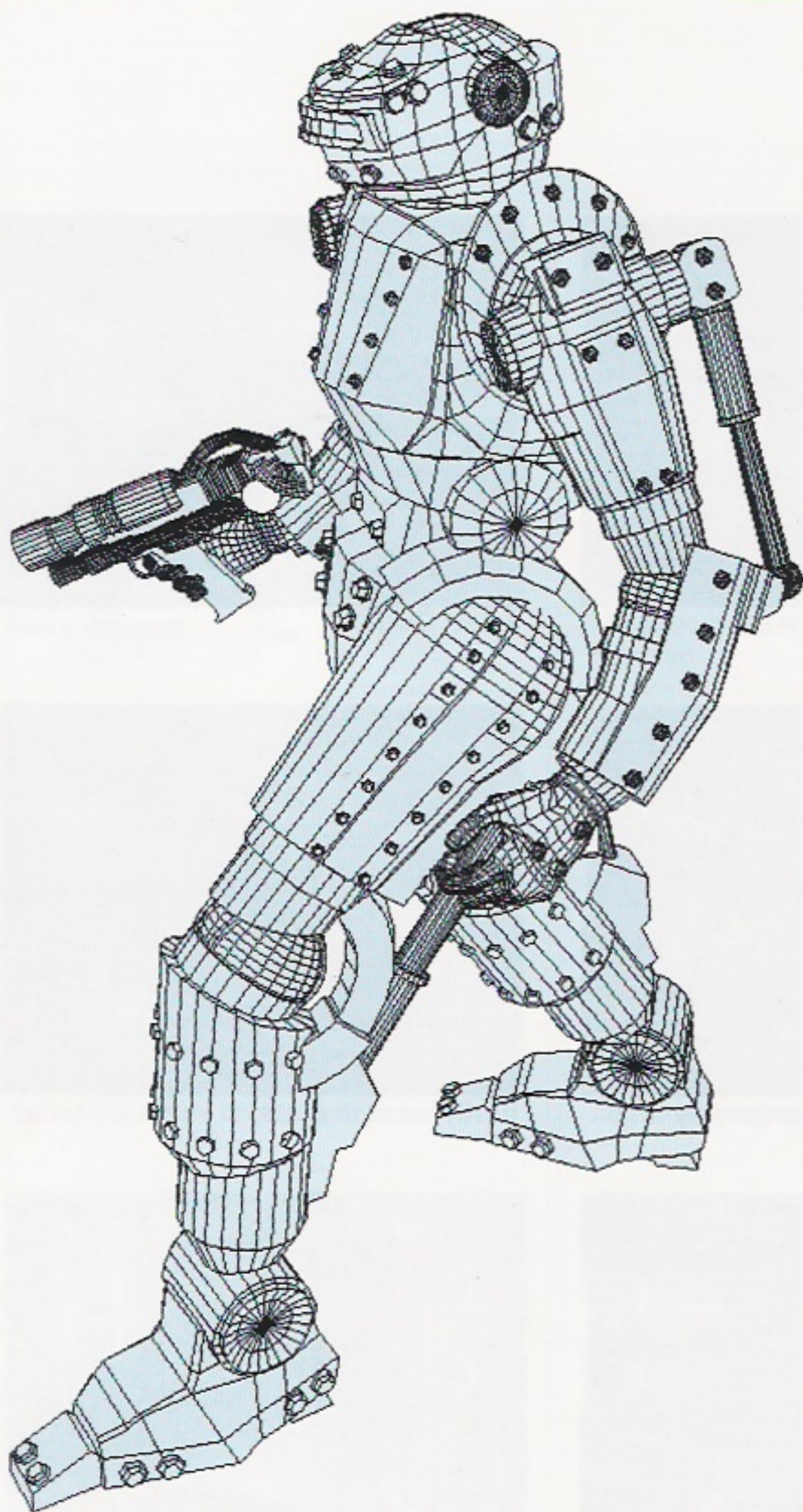



Armor that will endure every rigor of armed combat. The outward appearance of a heavy tank.

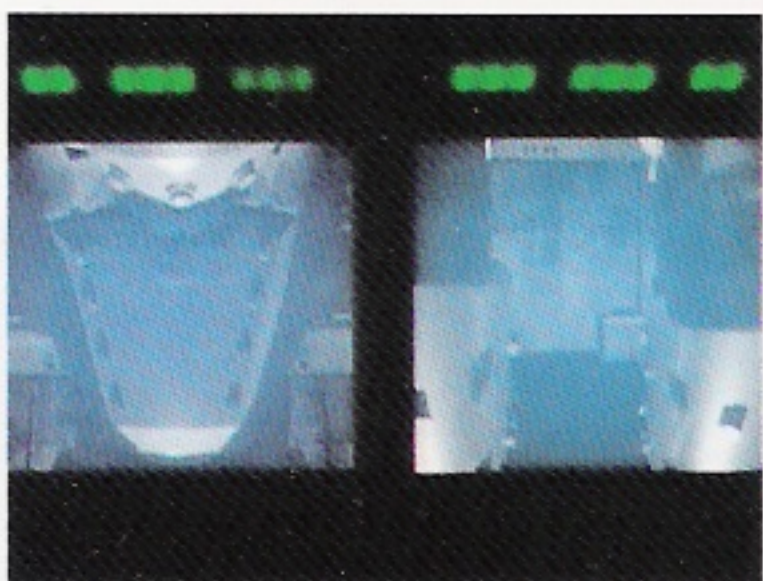

A unique alloy enables the bonding of human tissue with metal.

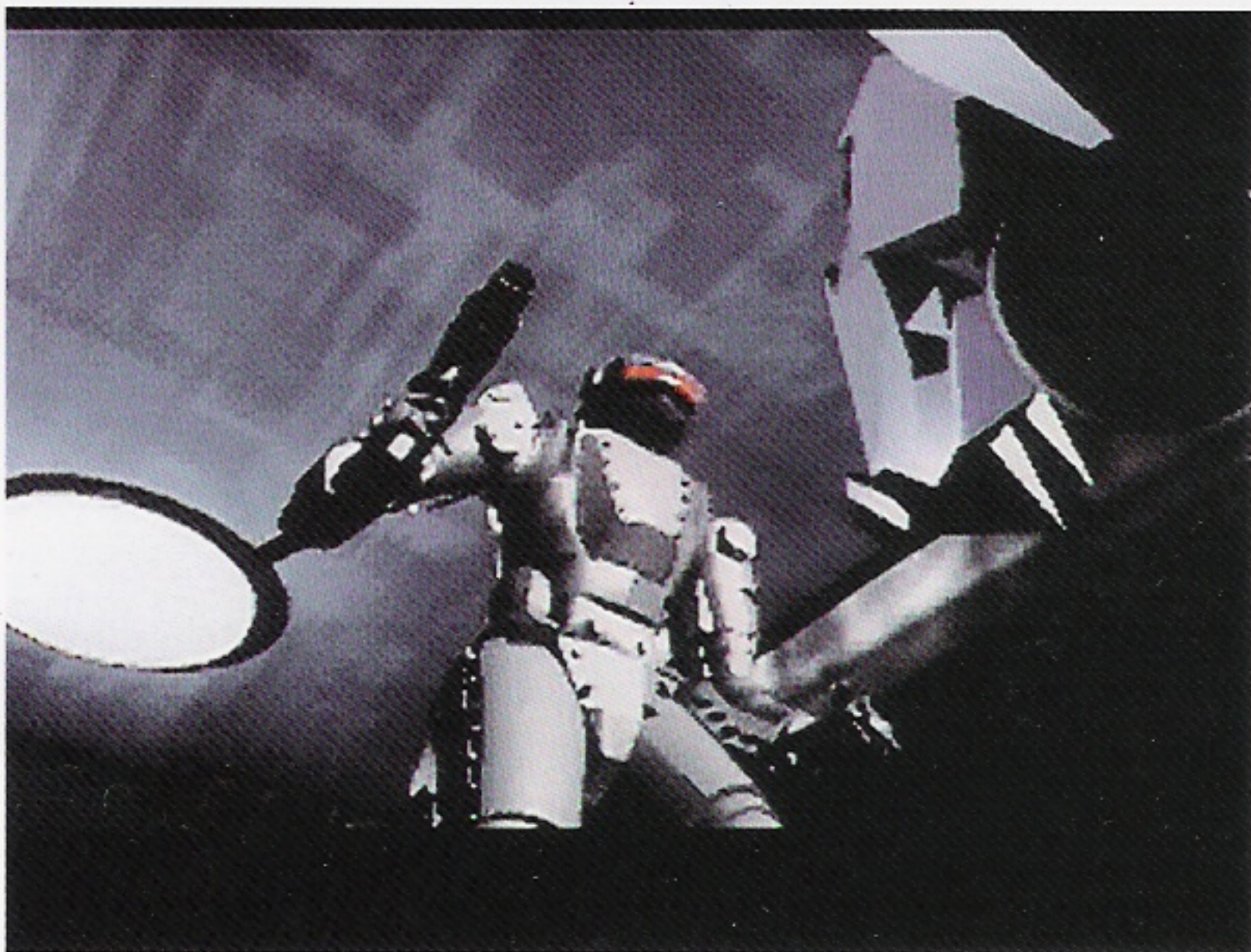
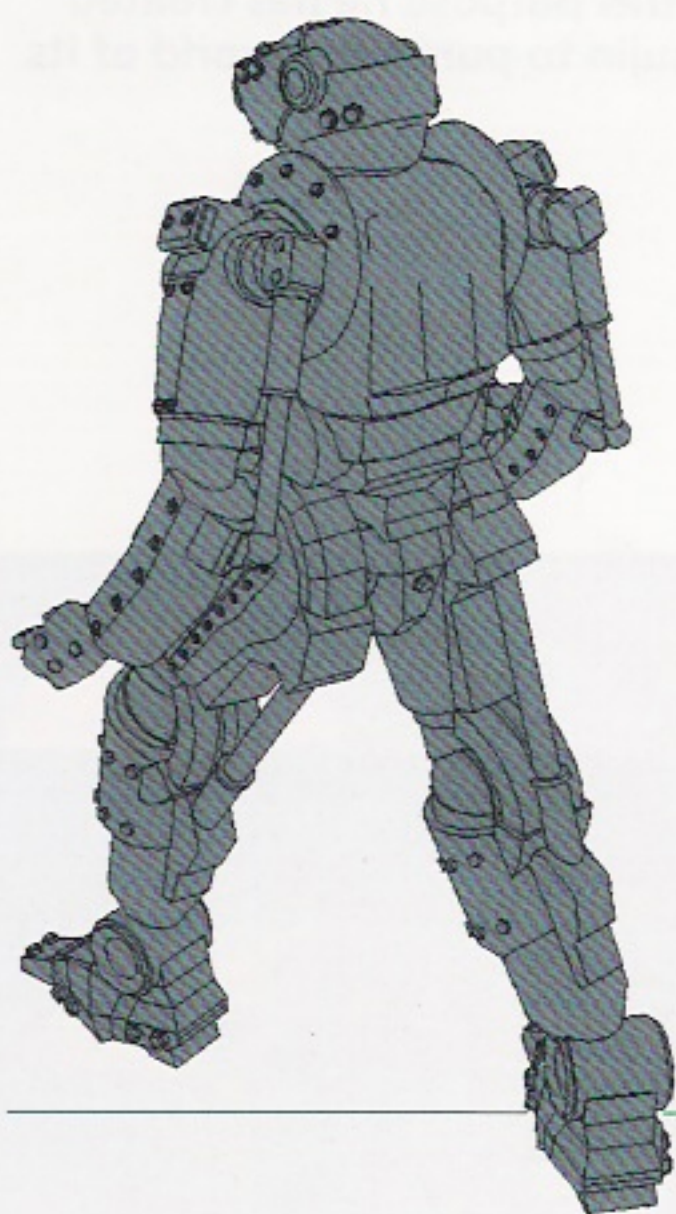

Using your arsenal of weapons, destroy the enemy motoids!

● **The Scientist**

The mad-genius scientist who developed Tetsujin. He believes that the inadequate organic system of the human body has outlived its usefulness and that humankind must now advance to a higher plane of development. For this purpose he has created Tetsujin to purge the world of its

human baggage.

At the top of a building in another dimension he has built his laboratory. Day and night his terrible experiments continue. The tower is designed as a labyrinth. A variety of traps have been set and motoids deployed in anticipation of Tetsujin's arrival.

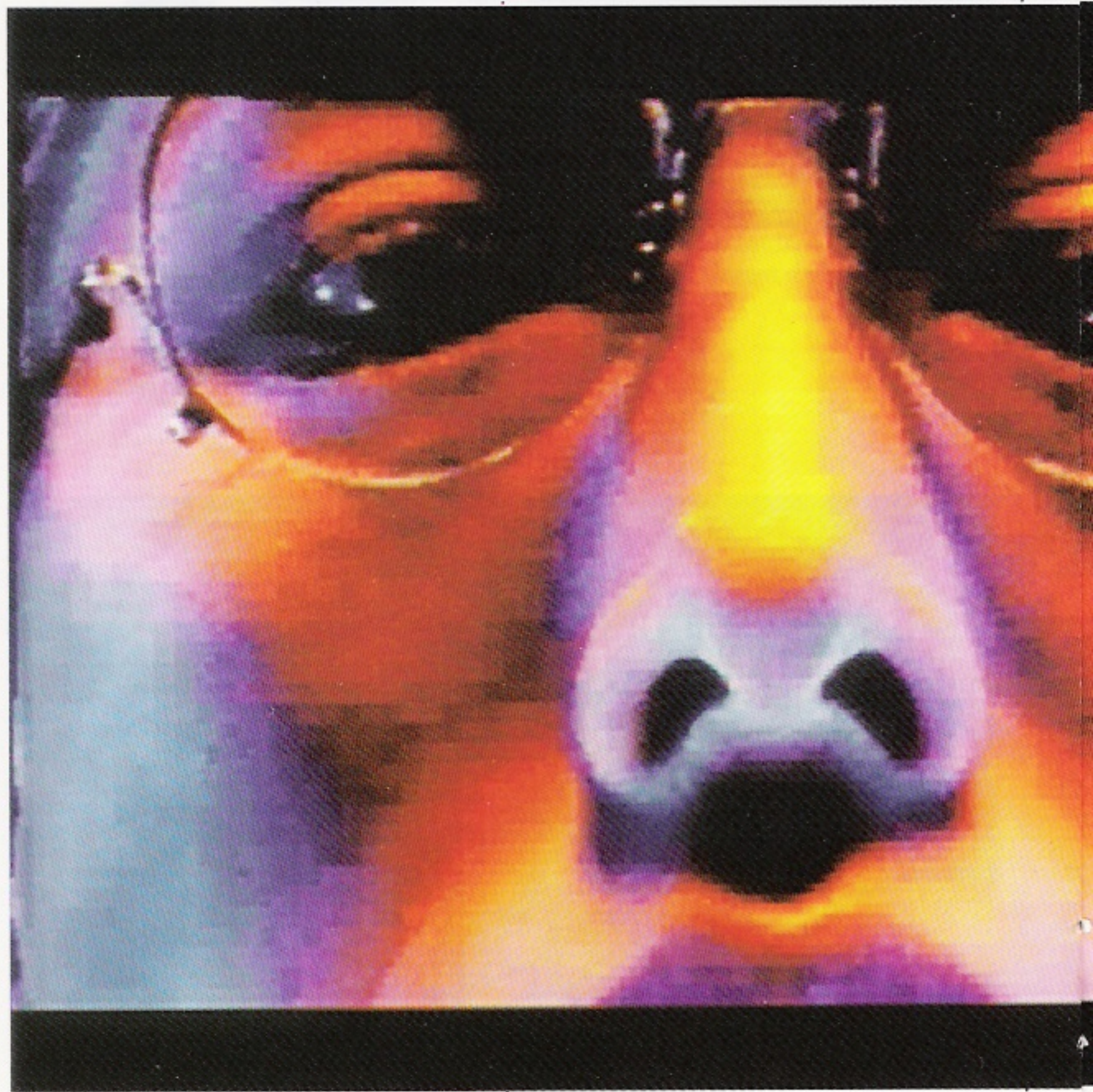



The scientist is on the monitor. He has a few things to tell you.

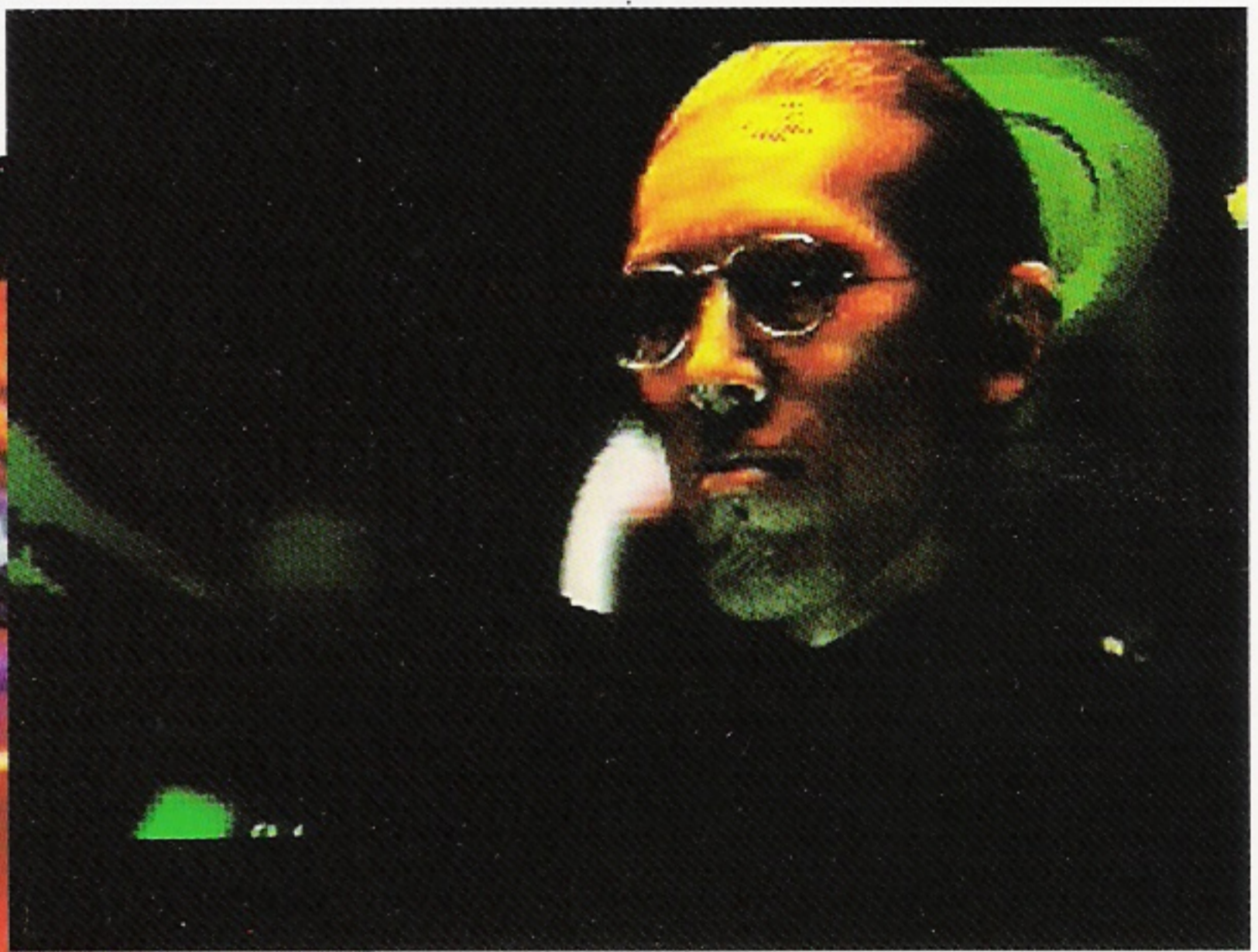

He's so smart he's crazy. Dangerous thoughts issue from this mind.



The lab's on the top floor. Find the scientist and stop Tetsujin's assimilation.

● **The Android**

Out of the blue, a mysterious robot transmits important information over your communications circuit. More than once will he tell you something that pulls you out of a

hot spot.

The android will be the direct source of unexpected revelations about Tetsujin and his important mission. He is a valued comrade who provides Tetsujin with help when he needs it.

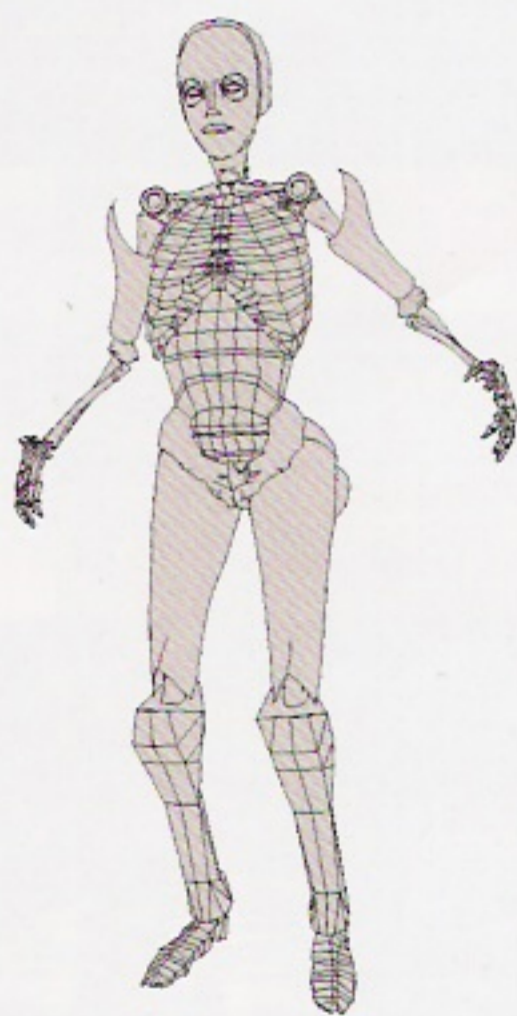
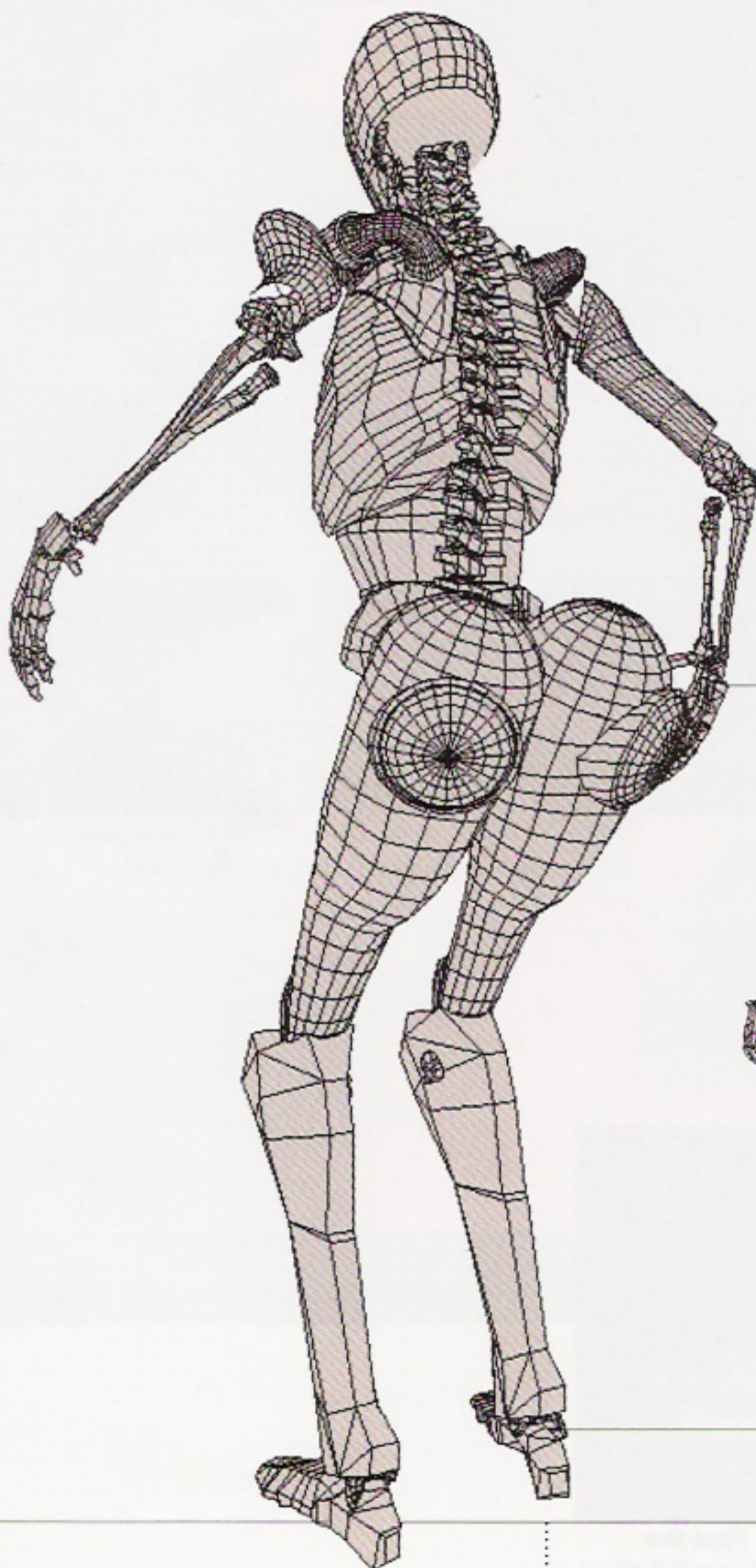

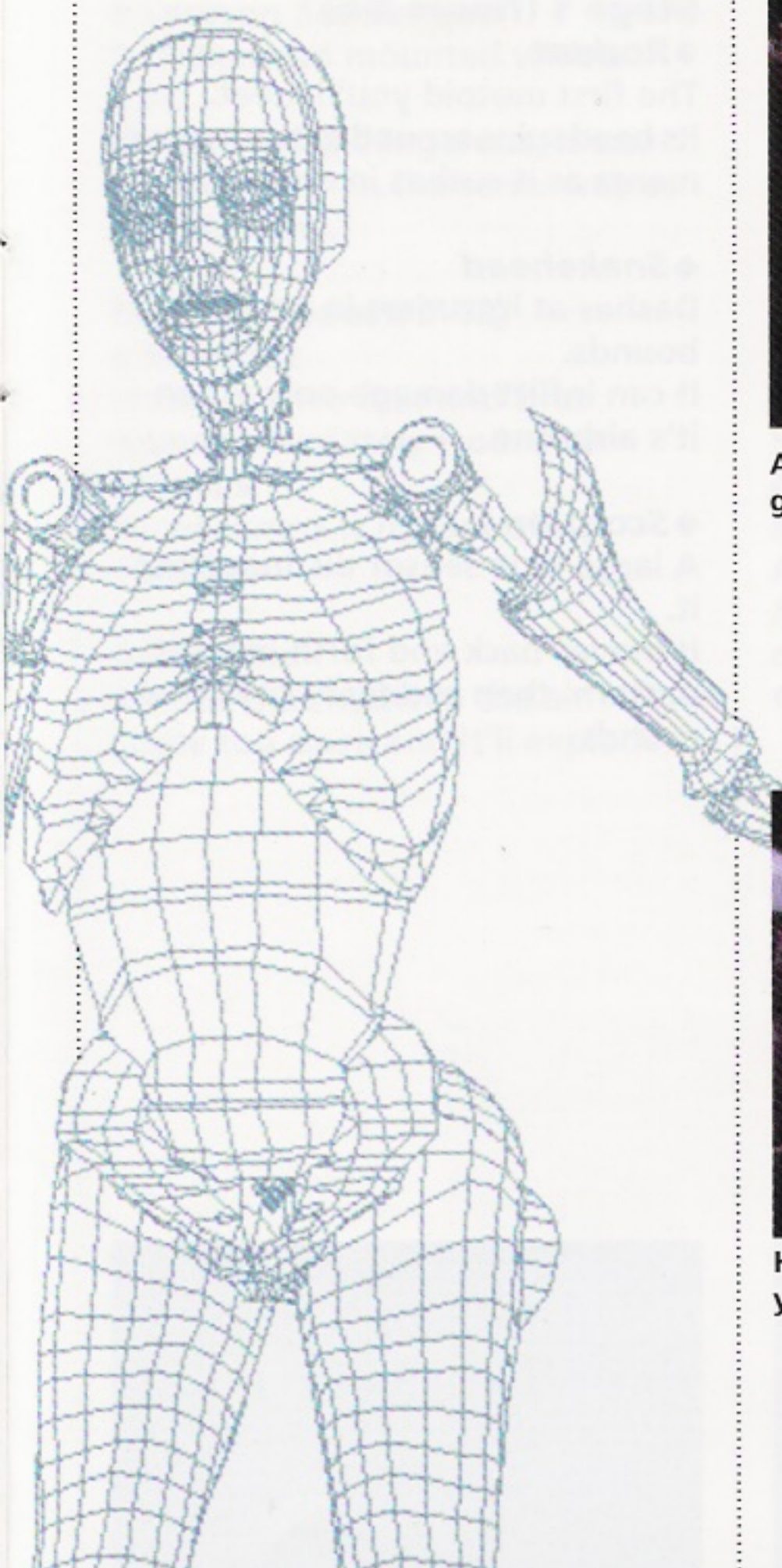

Put down your weapon

A strange aura emanates from his gleaming gold body.



Those motoids you destroyed

His slight build and clear intellect make you want to trust him.



There's one place where the wall's not so thick

He sends you useful bits of information through your communications circuit.

An Introduction to the Characters

● The Motoids

Motoids are battle robots that have been programmed to intercept and destroy all intruders into the tower. These too are products of the mad scientist's fertile brain. Development models from which Tetsujin was perfected, they are doomed to patrol the tower's corridors for all eternity. Motoids, from the swift of foot to the unstoppably strong, await you with bated breath. It's important to adjust your tactics to the characteristics of each type of motoid. If you don't, they'll do you.

Stage 1 (floors 1-6)

◆ Rodent

The first motoid you'll meet. Its head spins around to track movements as it rushes in on its prey.

◆ Snakehead

Dashes at intruders in leaps and bounds.

It can inflict damage only when it's airborne.

◆ Scorpion

A large blue sensor distinguishes it.

It moves back and forth in a set pattern, then suddenly fires two rounds.



Rodent

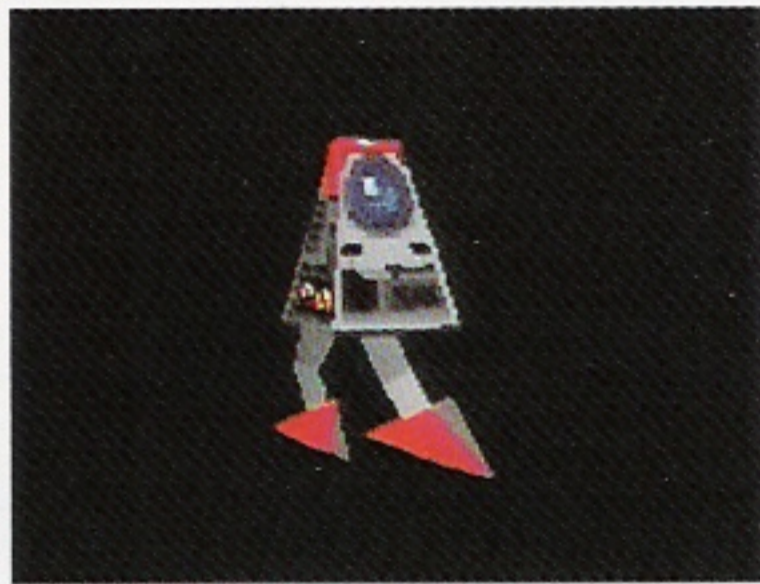

Scorpion

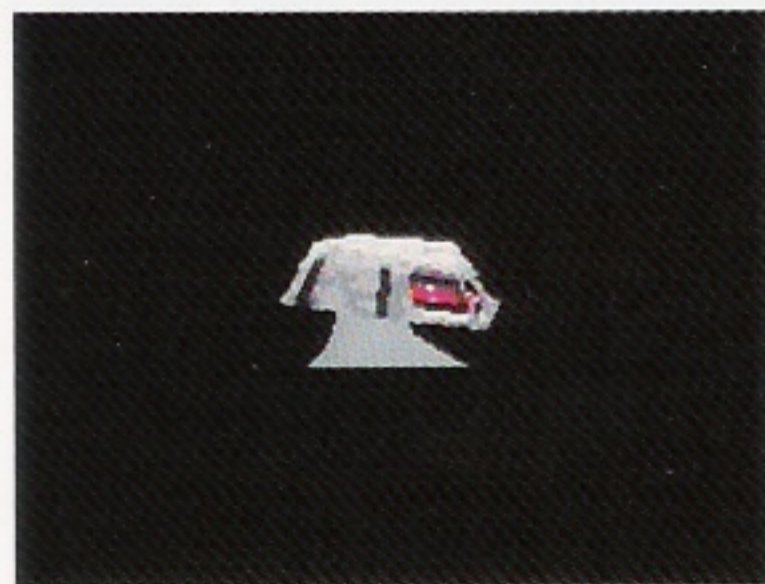

Snakehead



Cannon Snakehead

◆ **Cannon Snakehead**

A Snakehead mounted with a gun.

Though more dangerous, it can be dealt with in the same way as a Snakehead.

Stage 2 (floors 7-12)

◆ **Sluefoot**

Walks on two feet and fires rounds alternately from two cannons.

Its weakness is its lack of mobility.

◆ **Air Mine**

A mine that floats in the air. Come too close and it'll explode.

You may suffer damage when you destroy it.

◆ **Slither**

Shaped like a lopsided pyramid, a Slither rushes in at high speed. Back off as you fire or you'll take damage.

◆ **Bigfoot**

Similar to a Sluefoot, it's distinguished by the sloped armor of its brow.

Attacks down narrow corridors. A swift assault is the way to destroy it.



Sluefoot



Slither



Air Mine

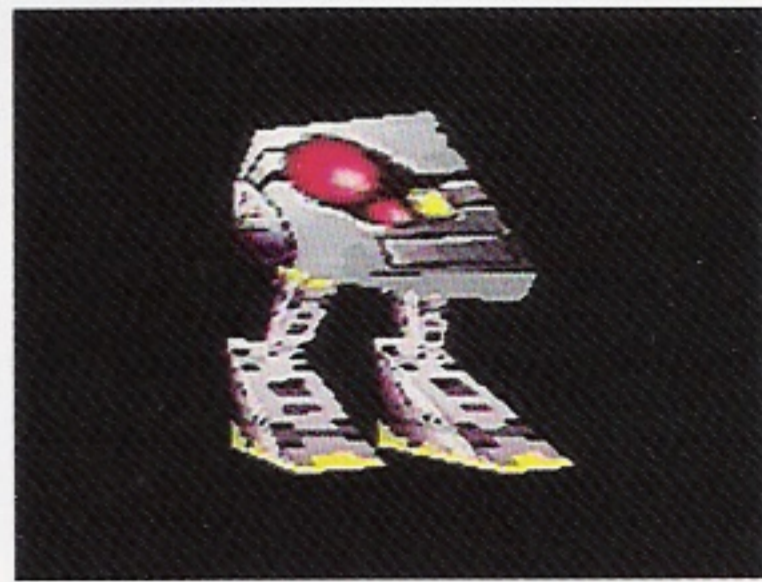

Bigfoot

An Introduction to the Characters

Stage 3 (floors 13-18)

◆ *Spearhead*

Though similar to a snakehead, it's a more powerful leaper. Its attack is fierce, and you should flank it or retreat as you fire.

◆ *Cobra*

A motoid copter. Draw near and

it will make repeated passes at you.

◆ *Jaws*

It can be destroyed only if a round strikes the instant its gates are fully opened. Watch out. It's a tenacious opponent.



Spearhead

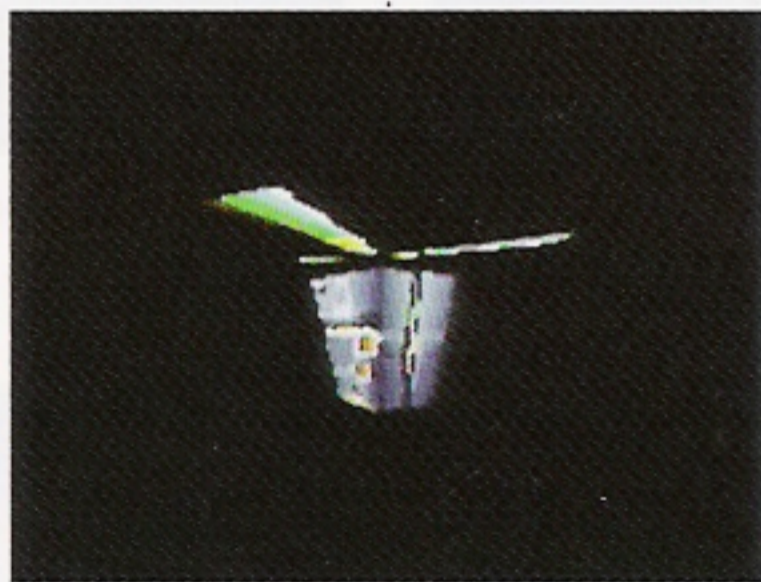

Cobra



Jaws

Stage 4 and beyond

◆ **Cutthroat**

With its spinning radar it will track you down from afar. It won't let up until it's stone dead.

◆ **Assassin**

A flying motoid, it will make repeated passes and explode if

you let it come too near. The best way to eliminate it is by surprise attack.

And there are still other motoids, hard as nails, waiting for a chance to do you in!

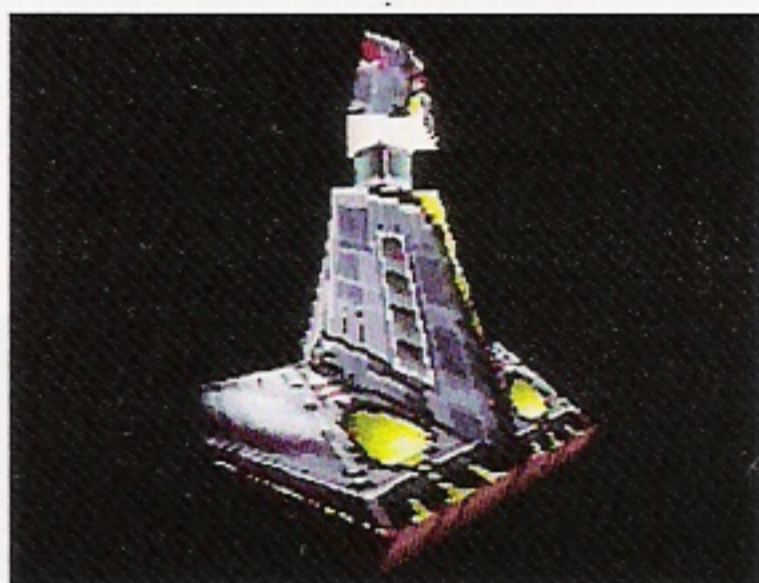

Cutthroat

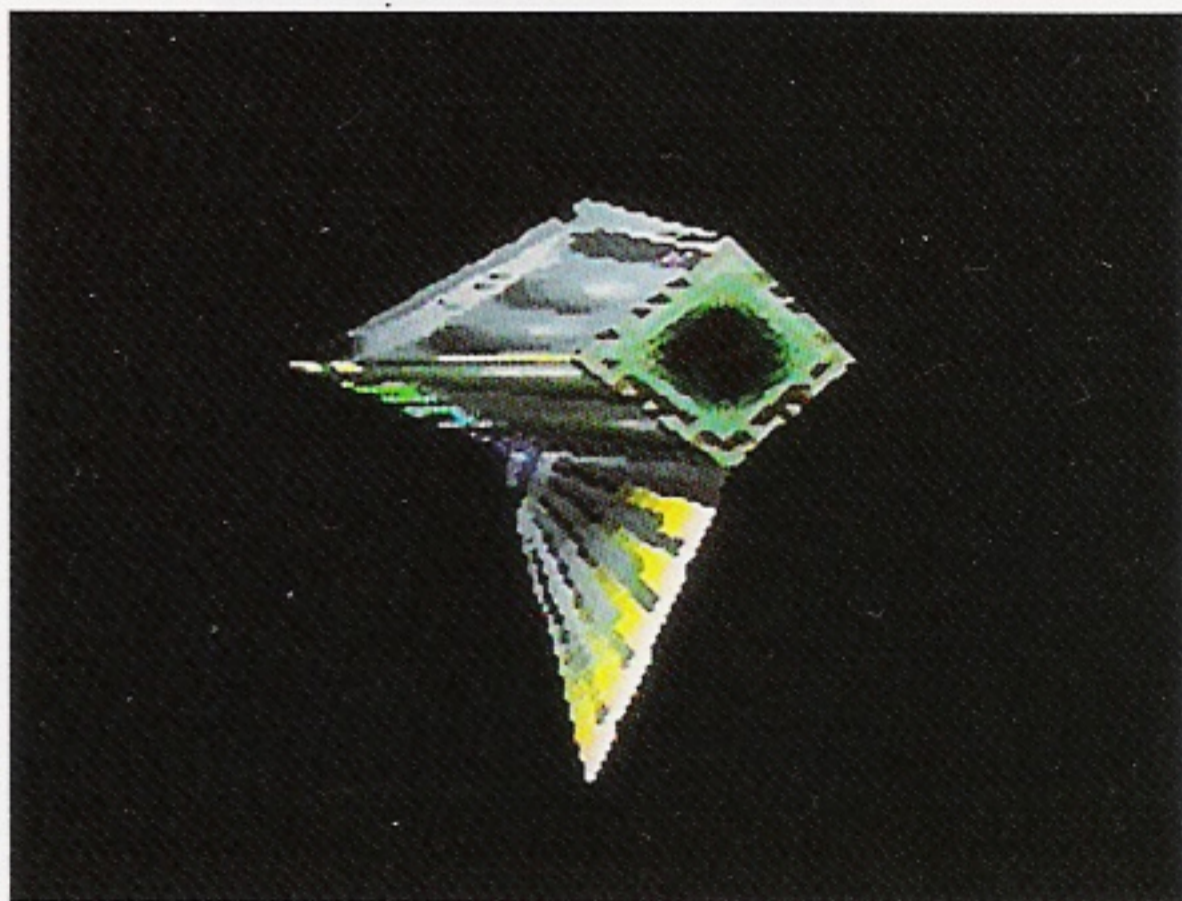

Assassin

An Introduction to Tetsujin's Weaponry

There are five firearms available for Tetsujin's use. At the outset Tetsujin is capable of operating only a machine pistol. But as the assimilation process advances, he gains the ability to use heavier weapons. These tools of mayhem are hidden in different stages, and you must look in every corner to find them.

◆ *Runt Gun*

A pistol that fires lead slugs. It comes into your hands when the game starts. 50 round magazine.

◆ *Big Heat*

Fires bursting shells. Rounds explode on contact and are capable of ripping through the armor of some motoids. It will be

found in Stage 2. 70 round magazine.

◆ *Gatling*

Fully automatic cannon with revolving barrels that fires eight rounds per second. It awaits you at Stage 3. 150 round magazine.

◆ *Bazooka*

Capable of destroying motoids with tank-grade armor. It is most effective when used alternately with the Gatling. 50 round magazine.

◆ *Secret Weapon*

A firearm of enormous destructive power developed by the mad scientist. No one knows where it is.



Runt Gun

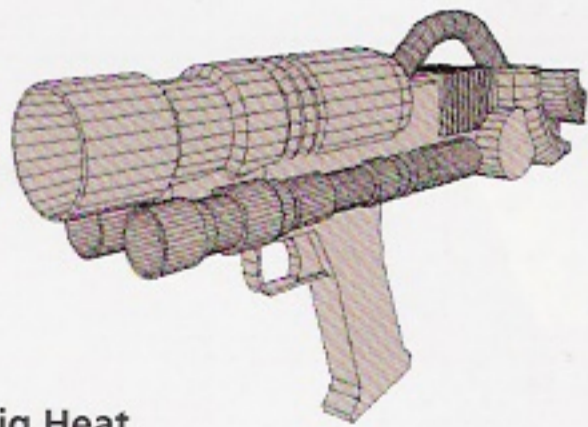

Big Heat

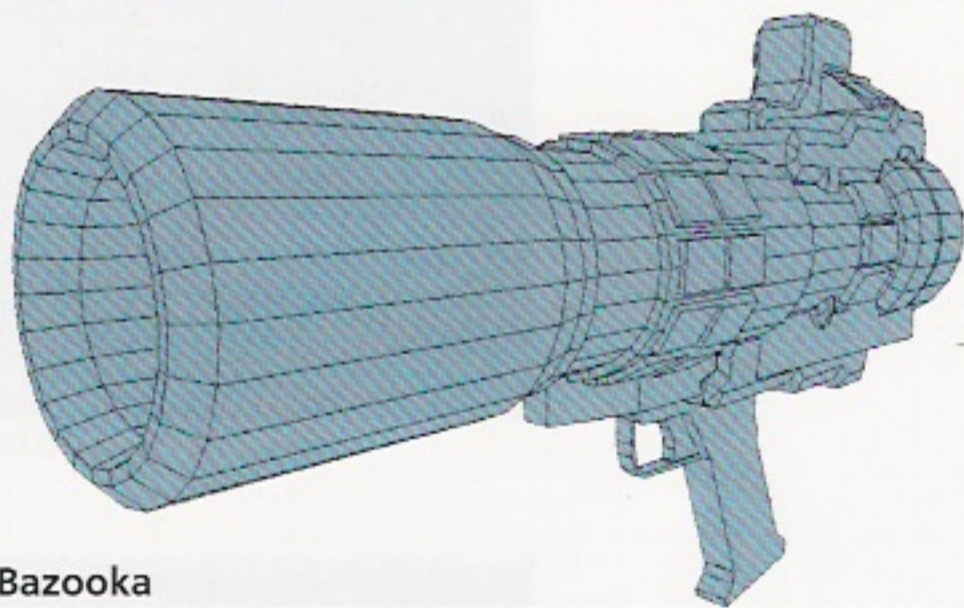

Bazooka

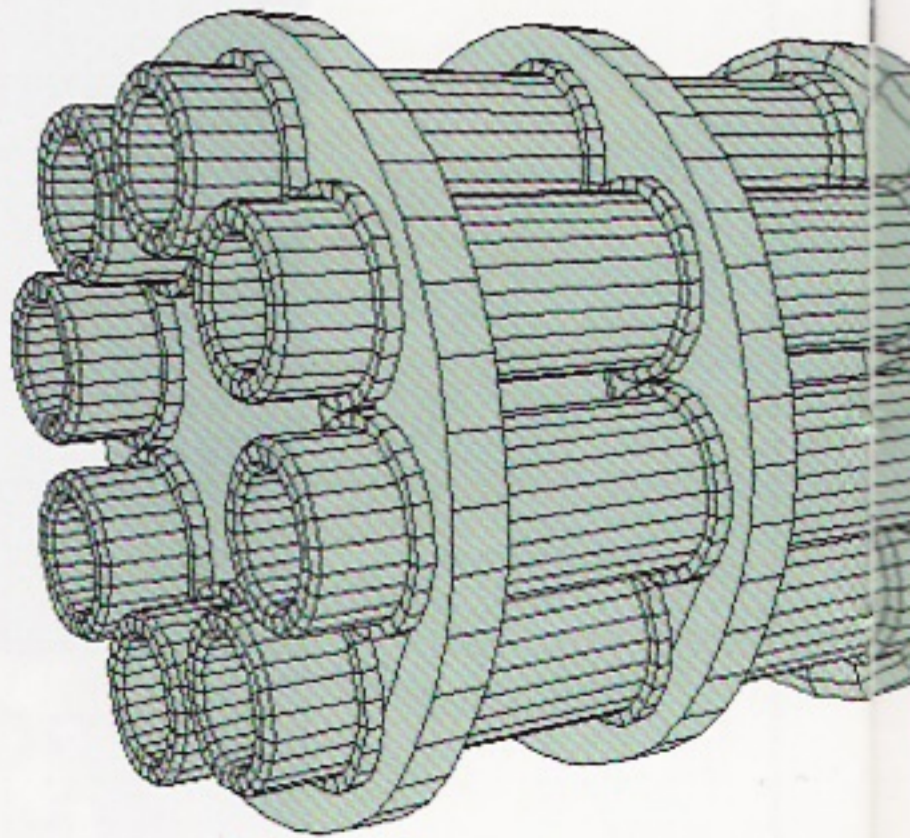

Gatling

Options

There are pieces of gear, located here and there in the stages, that redouble Tetsujin's battle strength when worn. Not only does possession of this gear stand you in good stead during combat, it also influences the development of the game.

◆ *Turbo Booster*

Puts wings on your feet. It is an invaluable piece of equipment for fighting fleet-footed motoids. A portion of its fuel is consumed every time you use it.

◆ *Shield*

Increases your capacity to withstand attack. The higher you go, the stronger the motoid, so be sure to get hold of it.

◆ *Radar*

Enables you to catch motoid movements behind your back or beyond walls. If you lose sight of a motoid you can track it by radar.

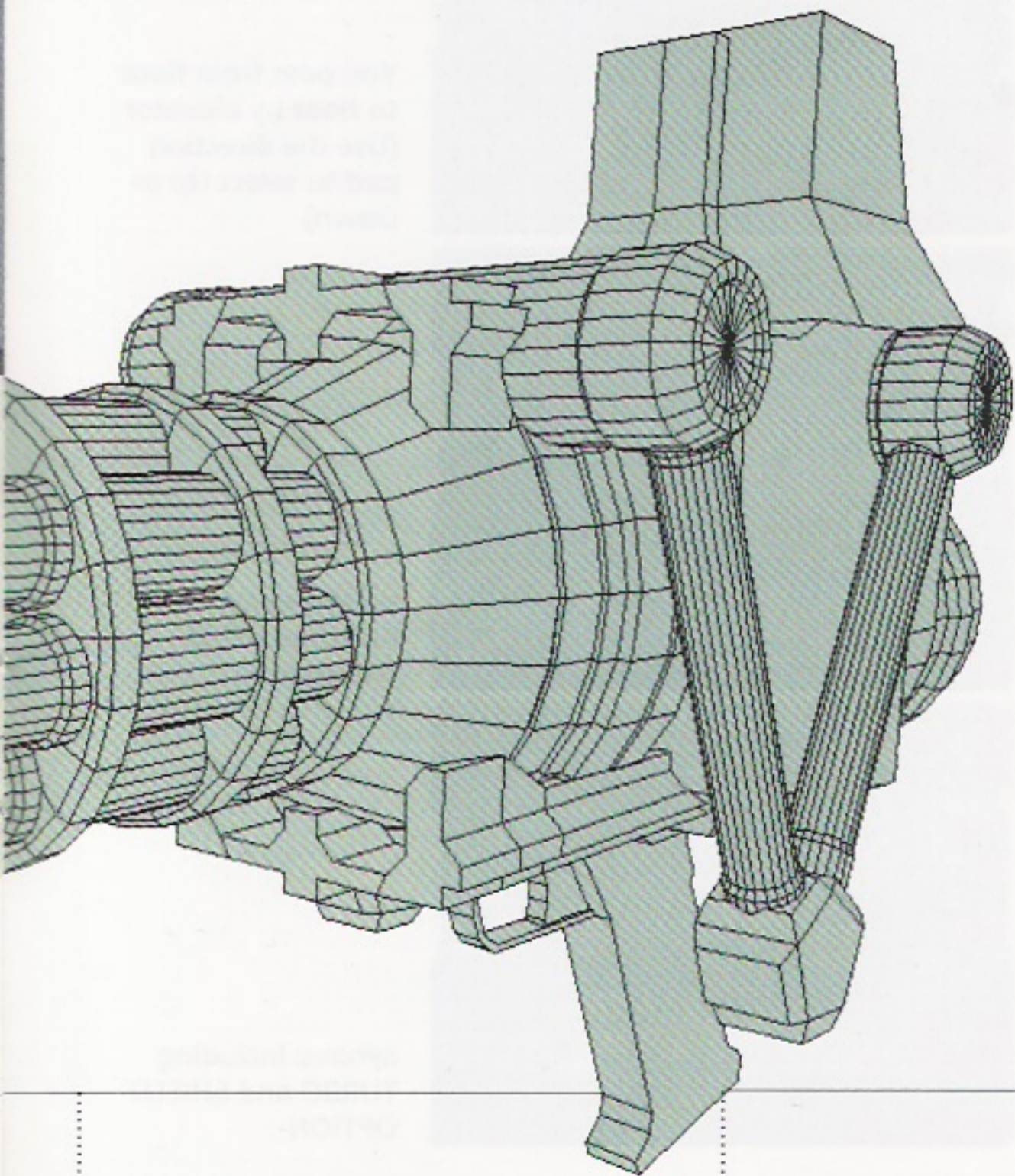

Assault Hints

Get Your Gear Together

Supplementary equipment may be hidden in tiny rooms or dead-end corridors. After getting hold of floor map data, don't head immediately for the elevator. Check out areas you haven't yet looked at before moving on to the next floor. Also, on the basis of the map, if there is an area of a floor that is obviously inaccessible, try reaching it from another floor. By selecting FLOOR MAP and using L- and R-shift you can change the floor that is being displayed. From the positions of the elevators, keep in mind what floors are accessible to each another.

What Types of Motoids are Out There?

In the case of some motoids, if your assault is not well timed, you will cause no damage. Try to get close and destroy each motoid without wasting a shot. Among motoids holed up in the tower, some will explode if you draw too near and you'll suffer crippling damage. So, don't press in too close to one of these motoids just to save ammo.

Never Turn Your Back on a Motoid

When going into battle take up a position that is easily defended from motoid attacks and from which an assault is easily mounted. On the basis of indoor

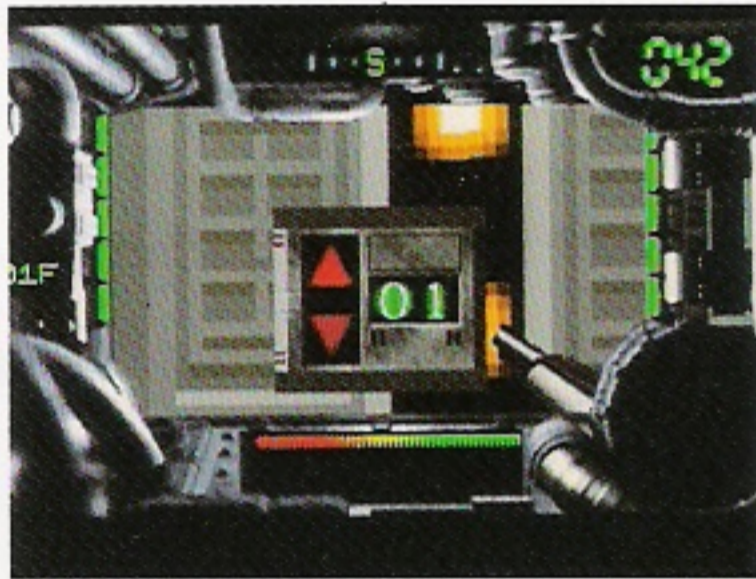

You pass from floor to floor by elevator (Use the direction pad to select Up or Down)

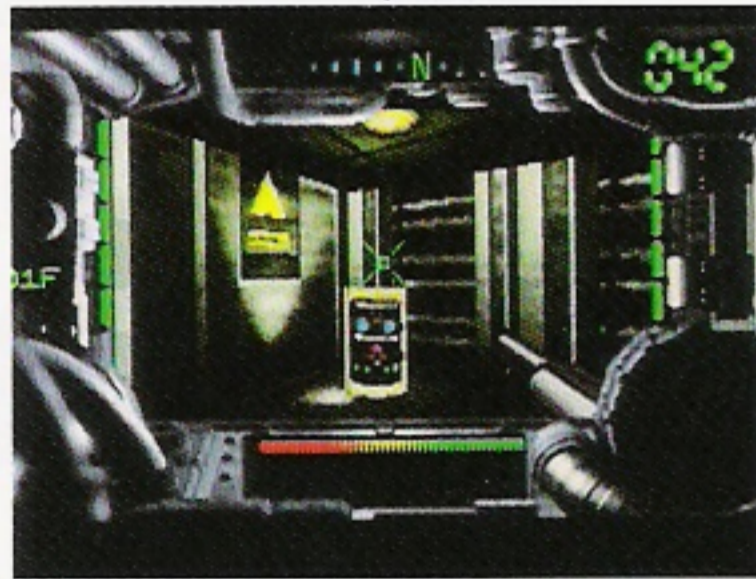

SHIELD ENERGY:
Restores shield damage

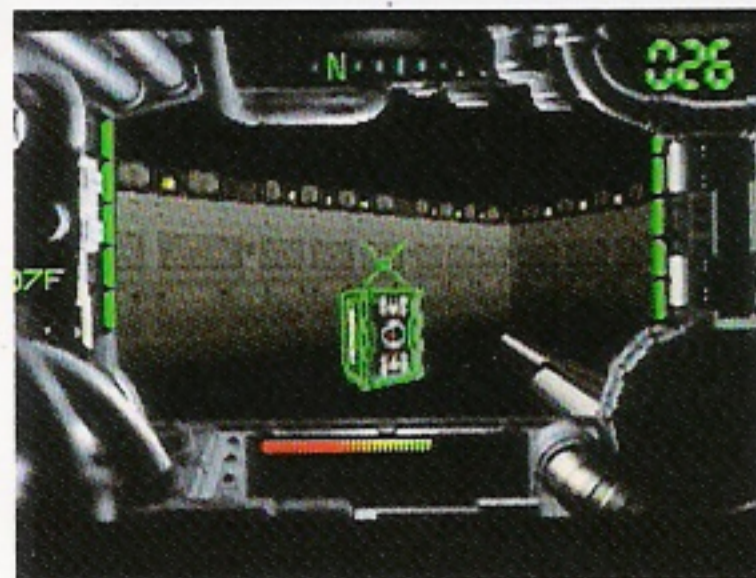

OPTIONS: Including
TURBO and SHIELD
OPTION

terrain and your knowledge of motoid patterns of movement, find the best place to make your stand.

Know Your Weapons

A weapon taken in hand can't be used unless it is first activated. As soon as you get hold of a weapon, arm it by selecting WEAPON CHANGE. If you find a magazine—an important piece of supplementary gear—you will be able to reload the weapon you are currently using, but if you should run out of ammo, quickly change to another weapon.

The Supply Room is Your Best Friend

Not only can you save data in the

Supply Room, but your weapons will be reloaded and your shield energy fully recharged. This applies as well to the turbo booster, which you will find on your way to the top story. When you get floor map data, immediately check the position of the supply room.

What can be Learned from the Movies?

When you clear each stage the screen will cut to a film clip. There are unexpected hints to be gained from things that are said in them. And pay particular attention to the movies of the middle stage and later.



MAGAZINE: Reloads the weapon you are now using

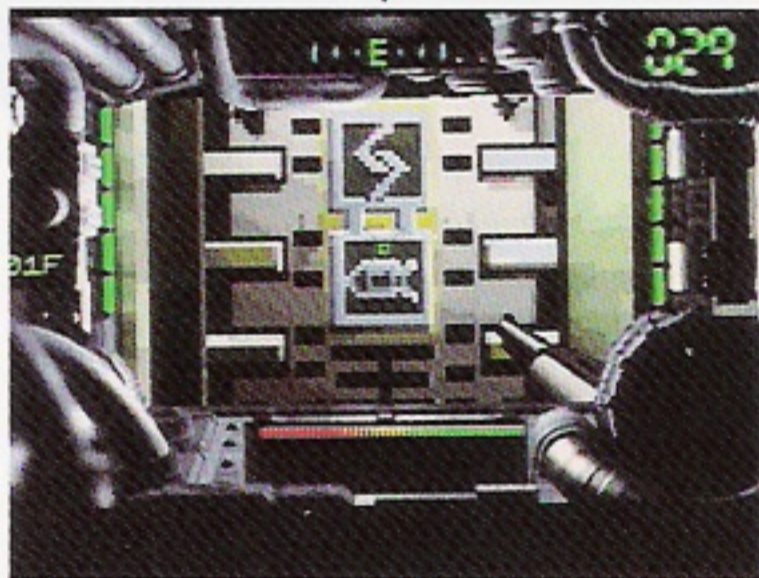

This door signals the Supply Room



The most powerful motoids on each floor lurk in the shadows

Assault Hints

Stage 1

In the preliminary engagements, the enemy are not so strong. But from the 3rd floor things become more difficult.

Stage 2

You have now met the android. Ahead, dark corridors and powerful motoids await you. Get into your Turbo Booster!

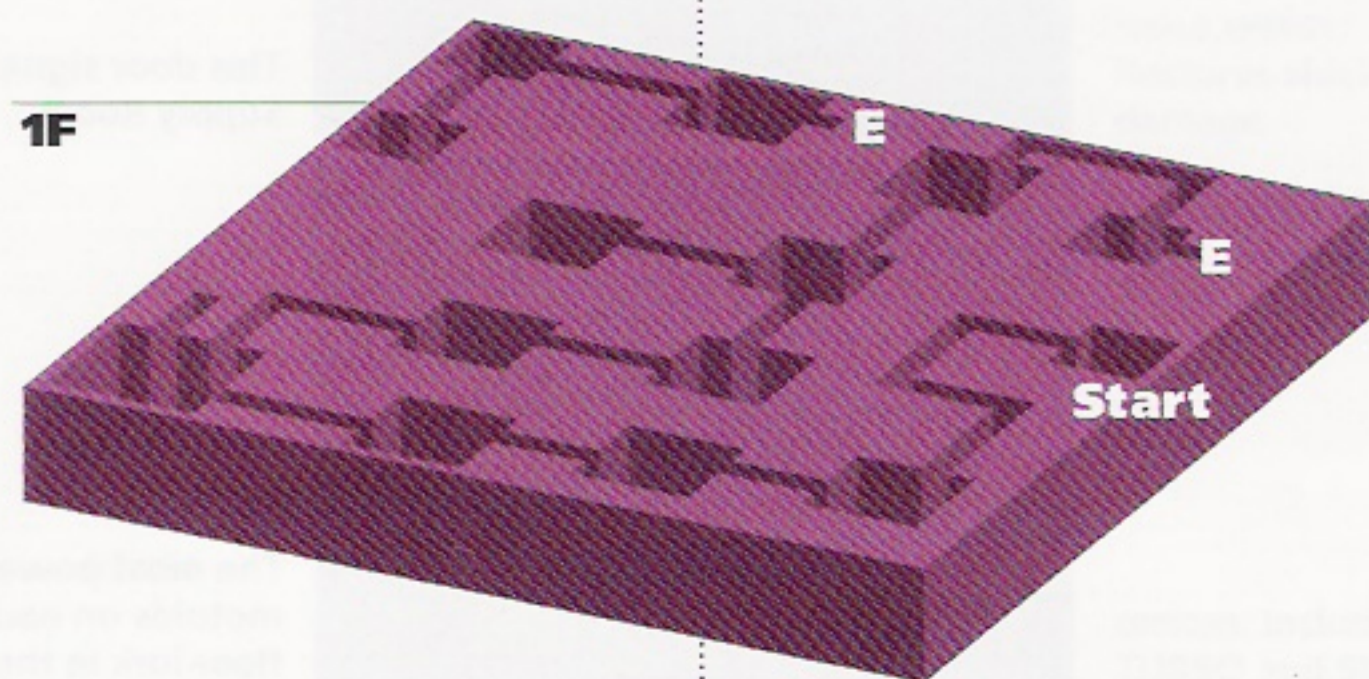
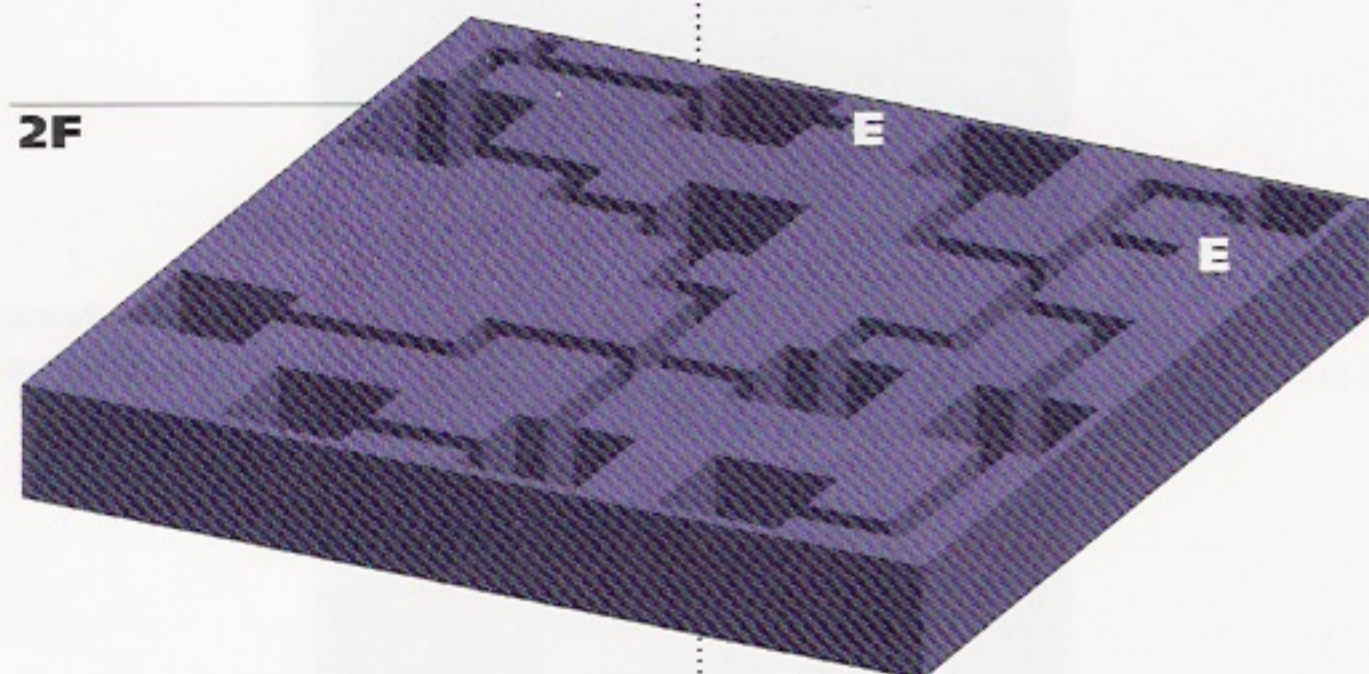
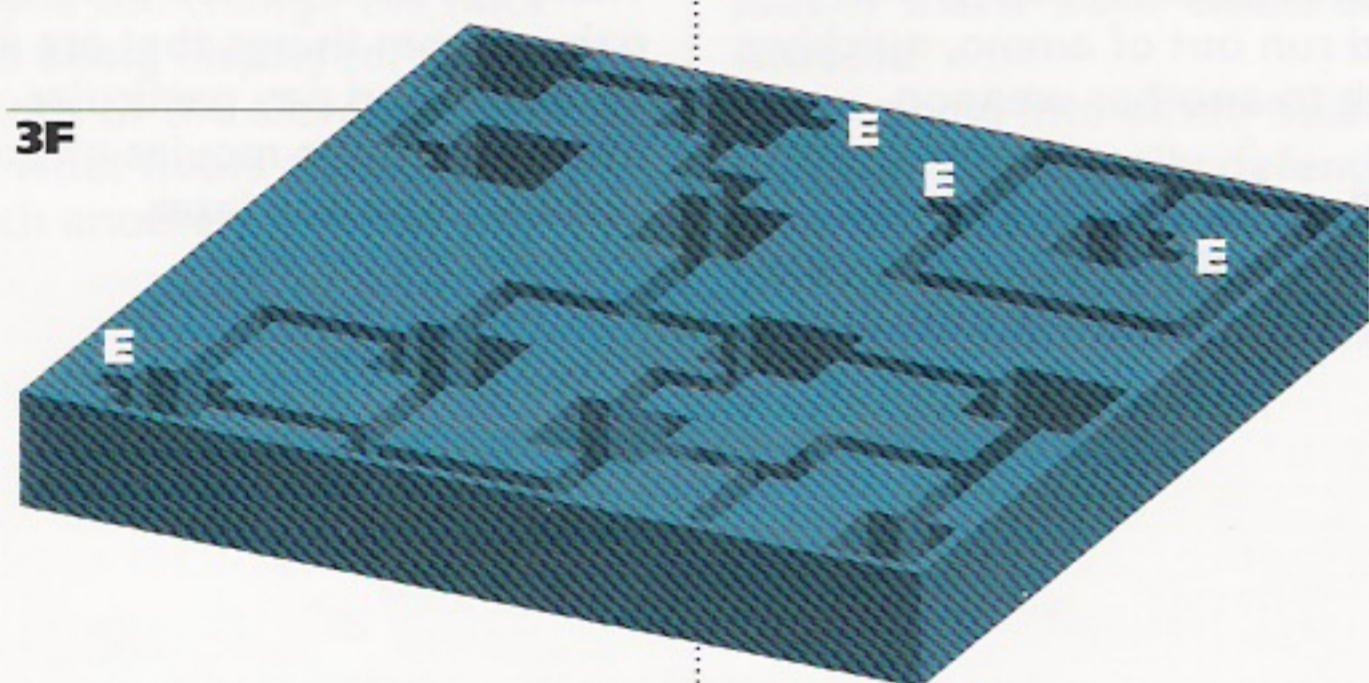

E = Elevator

Stage 3 and beyond

In a labyrinth of corridors you come upon Jaws. Watch out for the wall with a one-way door. Terrible fates await those who fall into the traps laid for intruders.

6F

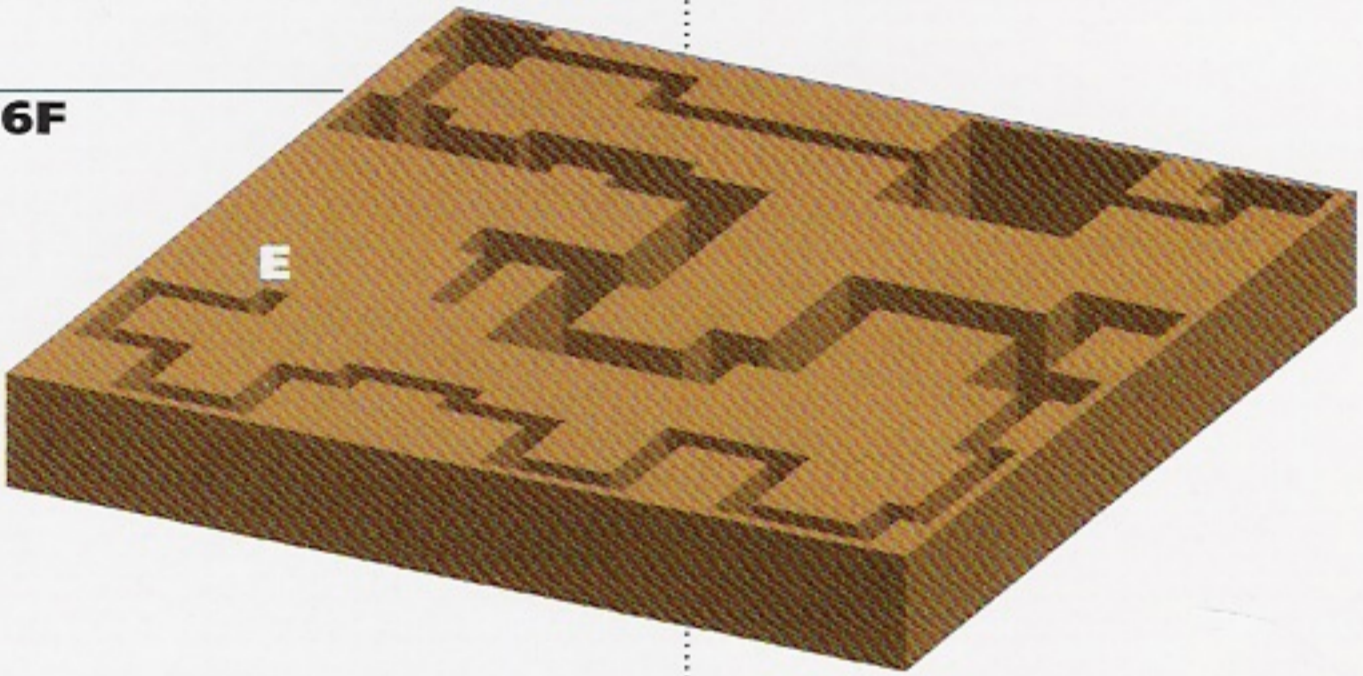

5F

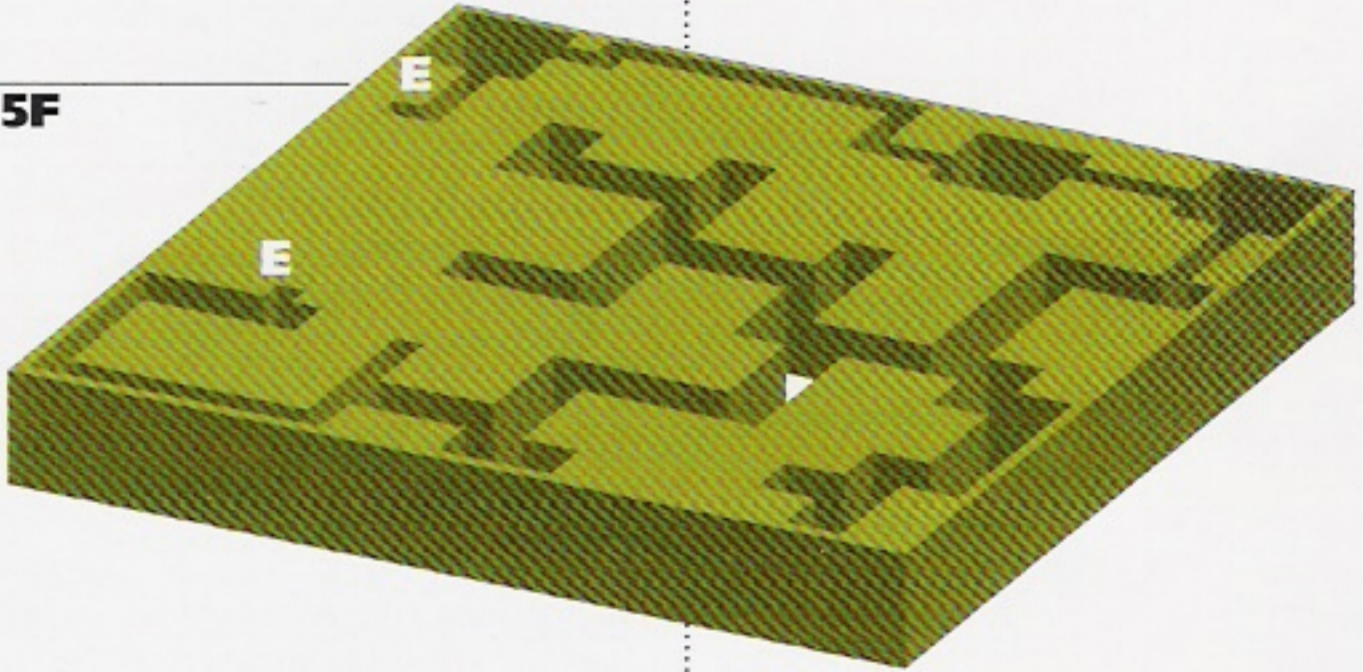

4F

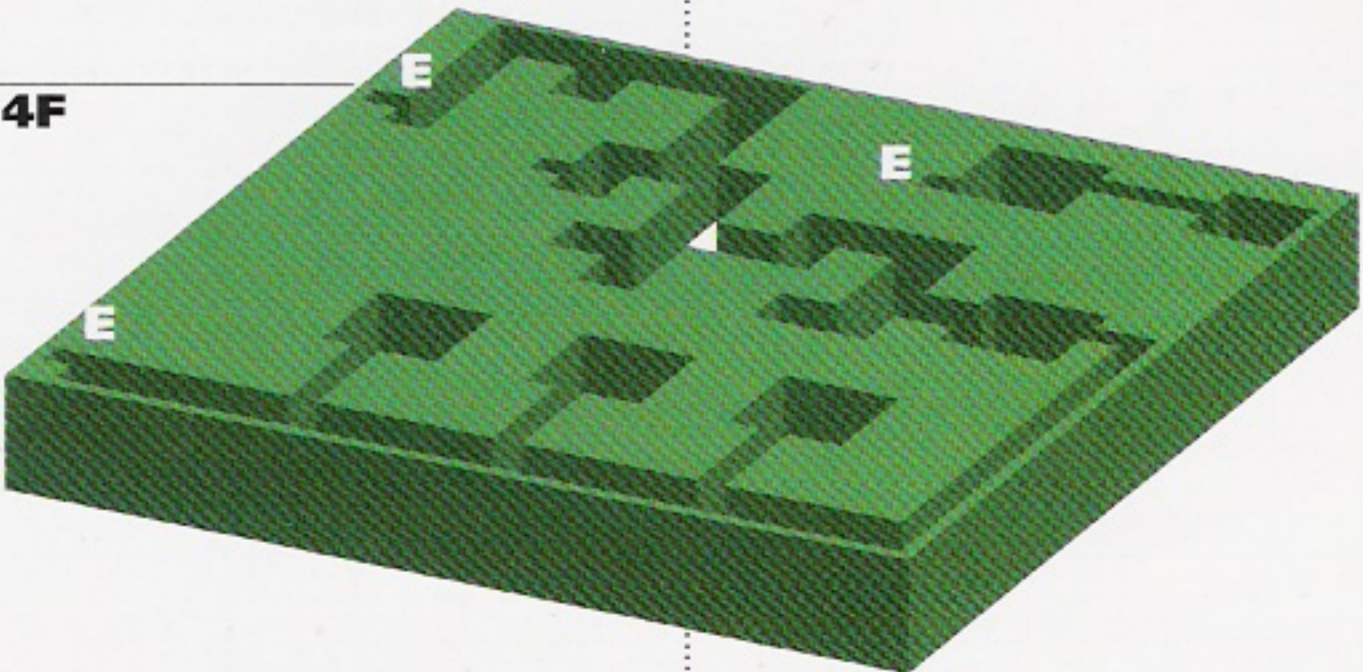

Credits

Chief Director

Minoru KUSAKABE (SYNERGY)

Performing Artist

Kyusaku SHIMADA

Audio Director

Norikazu MIURA

Game Created by

Masao ASAKAWA

Programmed by

Takakiyo MARUYAMA (SYNERGY)

Visuals Produced by

Minoru KUSAKABE (SYNERGY)

Keisuke SHIMADA (SYNERGY)

Hiroyuki MIURA (SYNERGY)

Film Staff

DIRECTOR:

Yasuhito NIWA

CAMERAMAN:

Masami UEMATSU

VIDEO ENGINEER:

Kiyomi CHIBA (IMAGICA)

ASST. CAMERAMAN:

Emiko MIYAUCHI (IMAGICA)

LIGHTING:

Mitsuhiro ENDOH (DOME)

LIGHTING HELPERS:

Hiroshi MIYAZAKI (DOME)

Katsutoshi HIRANO (DOME)

Ryota MORIURA (DOME)

AUDIO:

Munehiro OZAKI (Tamuko)

AUDIO HELPER:

Masami TSURUTA (Tamuko)

WARDROBE COORDINATOR:

Atsuko OHKI

COSTUMES:

Tiger Lily

HAIR AND MAKEUP STYLIST:

Mieko KURIMA

STILL PHOTOGRAPHY:

Isamu ISHIGE (RUBY'S ARMS)

DRIVER:

Minoru MITANI

FILM STUDIO:

Kurosawa Film Studio

GRIPS:

Manabu OHARAZAWA

Yuichi NOSE

MANAGER:

Hiromitsu TOYAMA

MULTI AUDIO STUDIO:

EIZOH ONKYO TSUSHINSYA

MULTI AUDIO MIXER:

Hiromitsu KUROKAWA

MANAGER:

Satoshi MIYAZAKI

PRODUCTION ASSISTANCE:

NK TOKKI

SANWA EIZAI

PRODUCED BY

Kazuya NOMOTO (WORKS RABBIT)

CAMERAWORK MANAGED BY

Kazutake OWA (WORKS RABBIT)

Package Designed by

Tatsuo HIDAKA

Englishing

David

Artists' Agents

Kyusaku SHIMADA

Chiaki AKATSUKA (OZ)

Norikazu MIURA

Miho YAMAURA (Staff Gang)

Special Thanks to

Hirokazu NABEKURA

Akihisa KOIKE

Tomomitsu NASUNO

Takehide NOZAKI

Jun TORITANI

Daishi KIMURA

Mitsuhiro SHINODA

Tetsuro SATOMI

Norikazu ISHIZU

Production Management

Yoshie IKEDA (SYNERGY)

Koji KATAYAMA (SYNERGY)

Toshihiro MASUMURA (SYNERGY)

Production Assistant

Saori EDA (SYNERGY)

Producer

Masanori AWATA (SYNERGY)

Planned and Developed by

SYNERGY, Inc.

Marketed by

SYNERGY INTERACTIVE Corp.

©1994 SYNERGY, Inc. All rights reserved.

SYNERGY, Inc. Limited Warranty

SYNERGY, Inc. warrants to the original consumer purchaser of this computer software product that the medium on which this computer software is recorded will be free from defects in materials and workmanship under normal use for a period of 90 days from the date of purchase. If the medium is found to be defective and returned to its Authorized Distributor, postage paid, in accordance with the RETURN INSTRUCTIONS written below, within such period, SYNERGY, Inc. agrees to replace, free of charge, any such defective medium as long as this computer software product is still manufactured by SYNERGY, Inc. In the event that the computer software product is no longer available, SYNERGY, Inc. retains the right to substitute a similar product of equal or greater value.

This warranty is limited to the recording medium only. Computer software is provided as is, without express or implied warranty of any kind. This warranty shall not be applicable and shall be void if the defect has arisen through abuse, misuse, neglect or normal wear and tear.

RETURN INSTRUCTIONS

- ◆ Certified mail is recommended for returns.
- ◆ To receive a replacement, you should enclose the original defective medium (including the original product label) only, in protective packaging accompanied by
 - a brief statement describing the defect you have encountered
 - your name and return address typed clearly,
 - a photocopy of your dated sales receipt, and
 - the model name or model number of your machine.
- ◆ Authorized Distributor to be returned to:
SYNERGY INTERACTIVE Corp.
333 South Hope St., Suite 2500, Los Angeles, CA 90071
Phone: (213) 687-2906 / Fax: (213) 687-2946
For CD-ROM Titles Support Desk call: 1-800-734-9466
(Any questions? Please call)
E-mail Address: westend@netcom.com

EXCEPT AS SET FORTH ABOVE, THIS WARRANTY IS IN LIEU OF ALL OTHER WARRANTIES, WHETHER ORAL OR WRITTEN, EXPRESS OR IMPLIED, INCLUDING ANY WARRANTY OF MERCHANTABILITY OR FITNESS FOR A PARTICULAR PURPOSE, AND NO OTHER REPRESENTATION OR CLAIMS OF ANY NATURE SHALL BE BINDING ON OR OBLIGATE SYNERGY, Inc. IN NO EVENT SHALL SYNERGY, Inc. BE LIABLE FOR ANY LOST PROFIT, OR OTHER SPECIAL, PUNITIVE, INCIDENTAL, OR CONSEQUENTIAL DAMAGE RESULTING FROM POSSESSION, USE, OR MALFUNCTION OF THIS PRODUCT, INCLUDING DAMAGE TO PROPERTY AND, TO THE EXTENT PERMITTED BY LAW, DAMAGES FOR PERSONAL INJURY, EVEN IF SYNERGY, Inc. HAS BEEN ADVISED OF THE POSSIBILITY OF SUCH DAMAGES.

Some states do not allow limitations as to how long an implied warranty lasts and/or exclusions or limitations of incidental or consequential damages, so the above limitations and/or exclusions of liability may not apply to you. This warranty gives you specific rights, and you may also have other rights which vary from state to state.

RETURNS AFTER WARRANTY

After the warranty period has expired, you may return a defective medium to the Authorized Distributor written in RETURN INSTRUCTIONS with a check or money order for \$15 U.S. currency, which includes postage and handling, per medium for replacement (must be within one year of purchase).

Software and documentation © 1994 SYNERGY, Inc. All rights are reserved. Iron Angel of the Apocalypse is a trademark of SYNERGY, Inc.

End User Notice

THE 3DO COMPANY SHALL NOT BE LIABLE TO THE END USER FOR ANY LOSS OF DATA, LOST PROFITS, COST OF SUBSTITUTE GOODS OR OTHER CONSEQUENTIAL, INCIDENTAL, SPECIAL, PUNITIVE, OR OTHER DAMAGES OF ANY KIND ARISING OUT OF THE USE OF OR INABILITY TO USE THE SOFTWARE.

THE 3DO COMPANY MAKES NO WARRANTIES, EXPRESS, IMPLIED OR STATUTORY, REGARDING THE SOFTWARE, INCLUDING WITHOUT LIMITATION THE IMPLIED WARRANTIES OF MERCHANTABILITY AND FITNESS FOR ANY PARTICULAR PURPOSE, OR ANY EQUIVALENT WARRANTIES UNDER THE LAWS OF ANY JURISDICTION.

DO NOT USE A FRONT OR REAR PROJECTION TELEVISION WITH THIS PRODUCT. YOUR PROJECTION TELEVISION SCREEN MAY BE PERMANENTLY DAMAGED IF STATIONARY SCENES OR PATTERNS ARE PLAYED ON YOUR PROJECTION TELEVISION. SIMILAR DAMAGE MAY OCCUR IF YOU PLACE THIS PRODUCT ON HOLD OR PAUSE.

IF YOU USE YOUR PROJECTION TELEVISION WITH THIS PRODUCT, NEITHER THE 3DO COMPANY NOR SYNERGY, Inc. WILL BE LIABLE FOR ANY RESULTING DAMAGE. THIS SITUATION IS NOT CAUSED BY A DEFECT IN THIS PRODUCT OR THE 3DO SYSTEM; OTHER FIXED OR REPETITIVE IMAGES MAY CAUSE SIMILAR DAMAGE TO A PROJECTION TELEVISION. PLEASE CONTACT YOUR TV MANUFACTURER FOR FURTHER INFORMATION.

THE EXECUTION OF SOFTWARE WITH THE 3DO SYSTEM INVOLVES THE USE OF PATENT RIGHTS, GRANTED OR APPLIED FOR, IN CERTAIN COUNTRIES. A PURCHASER OF THE 3DO SYSTEM IS LICENCED TO USE SUCH PATENT RIGHTS WITH SOFTWARE LICENCED BY THE 3DO COMPANY. NO LICENCE, IMPLIED OR OTHERWISE, IS GRANTED FOR THE EXECUTION OF OTHER SOFTWARE.



S Y N E R G Y I N C.



This software product is distributed only for personal use of the original consumer purchaser on a single machine. All other rights reserved. Unauthorized reproduction, distribution (including rent or lease by way of trade or transmission by network) or public performance of this software product is strictly prohibited by law.

3DO, the 3DO logos and Interactive Multiplayer are trademarks of The 3DO Company.