



THE INCREDIBLE MACHINE™



THE INCREDIBLE MACHINE

*“Puzzlemania is 99% perspiration
and 1% inspiration.”*

—Anonymous

Contents

• INTRODUCTION	
• 3DO INTERACTIVE MULTIPLAYER SYSTEM	2
• OPENING MENU	3
• PUZZLE PLAY AREA	4
• SOLVING PUZZLE NUMBER ONE	5
• HELPING HAND CURSORS	6
• 3DO CONTROLLER A BUTTON	7
• B BUTTON MENU • MANIPULATING PARTS	8
• C BUTTON MENU	10
• SHORT CUTS AND HELPFUL HINTS	11
• SOLVED PUZZLE MENU • PUZZLE PLAY MENU	12
• SELECTING PUZZLES • SCROLLING PUZZLES	13
• CUSTOMIZING MENU	14
• JUKEBOX SCREEN	15
• MAKE A MACHINE	16
• MAKE A MACHINE MENU	17
• PARTS BIN EDITOR	18
• SAVE A MACHINE	19
• TO LOAD A PREVIOUSLY SAVED MACHINE • FILE ERROR MESSAGE	20
• TUTORIAL AREA	21
• TRICKY PARTS	22
• LIST OF PARTS	23
• GAME CREDITS	27
• TECHNICAL SUPPORT	28

The Incredible Machine— What's It All About?

If you're the kind of person who gets off on gadgets and gizmos and insanely complicated contraptions, you're going to go wild over *The Incredible Machine*.

There are 208 puzzles here awaiting your creative genius. Basically, the game works like this: you get a puzzle, a goal, and a bunch of spare parts. Your challenge is to figure out how the spare parts fit in to solve the puzzle. Or, you can become the Machine Maker and build your own puzzles. See how weird and tough and crazy you can make them. Then test them out on your pals. But be careful...too much Machine Mania can have some pretty spooky side effects.

Your 3DO™ Interactive Multiplayer™ system

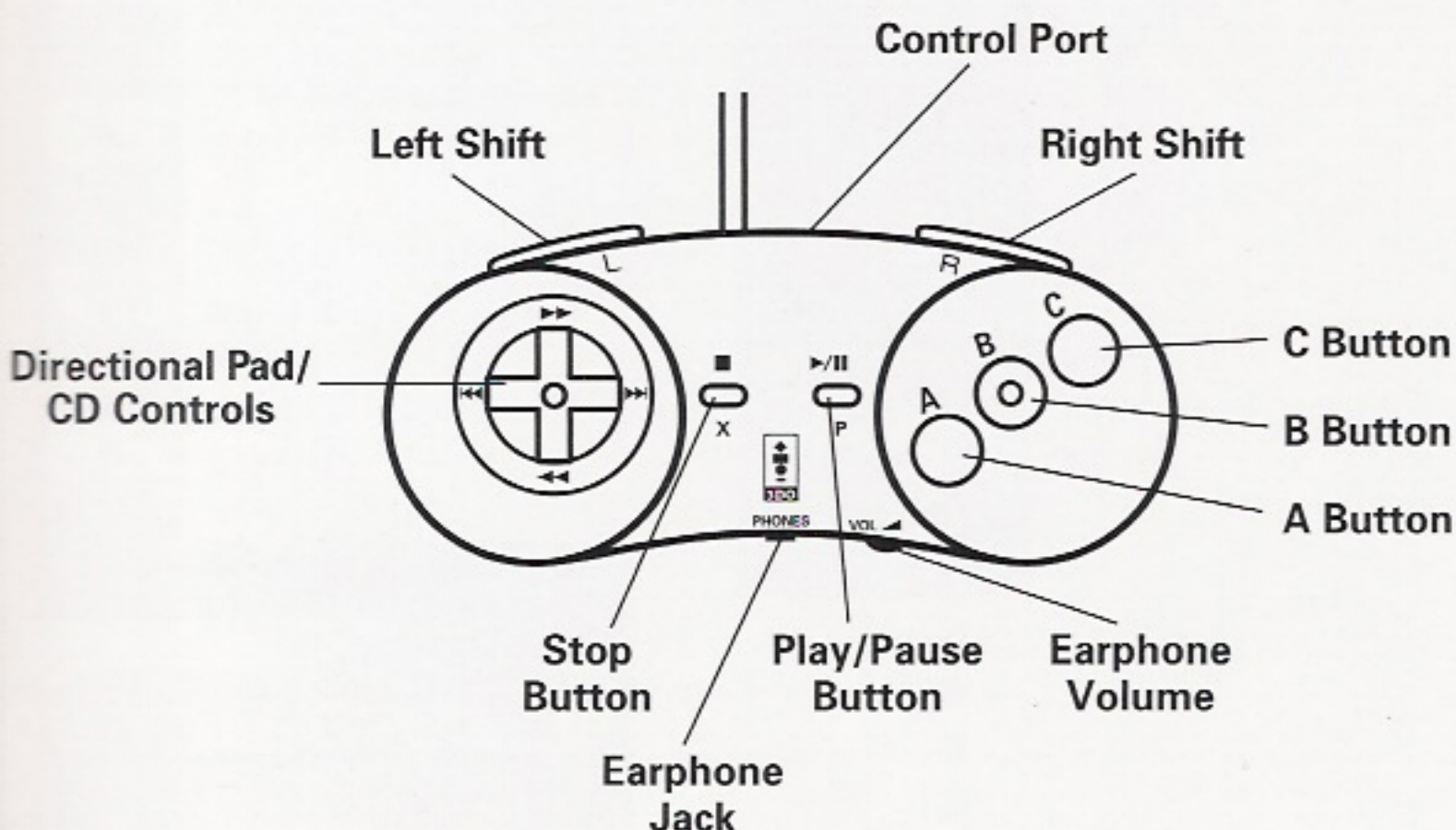
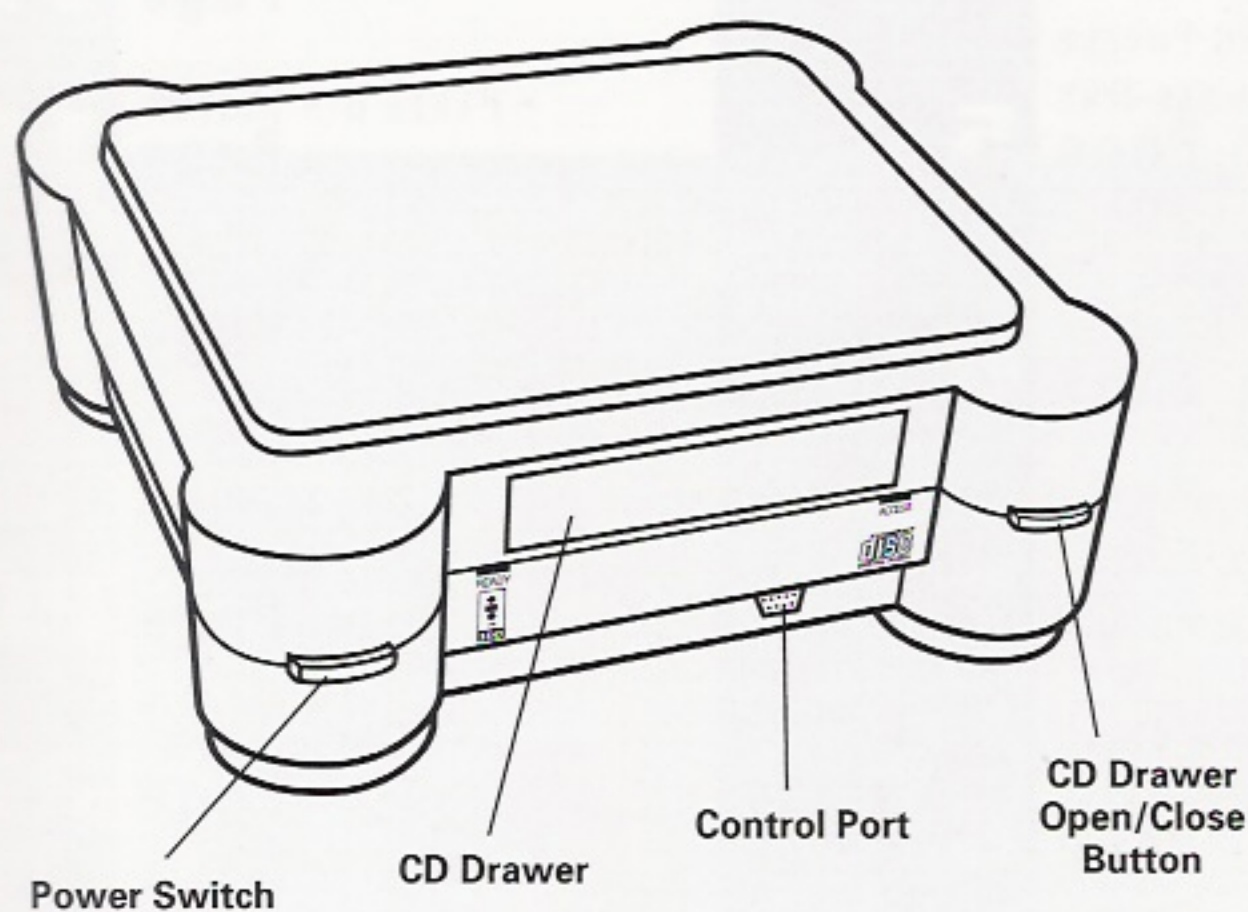

OPENING MENU

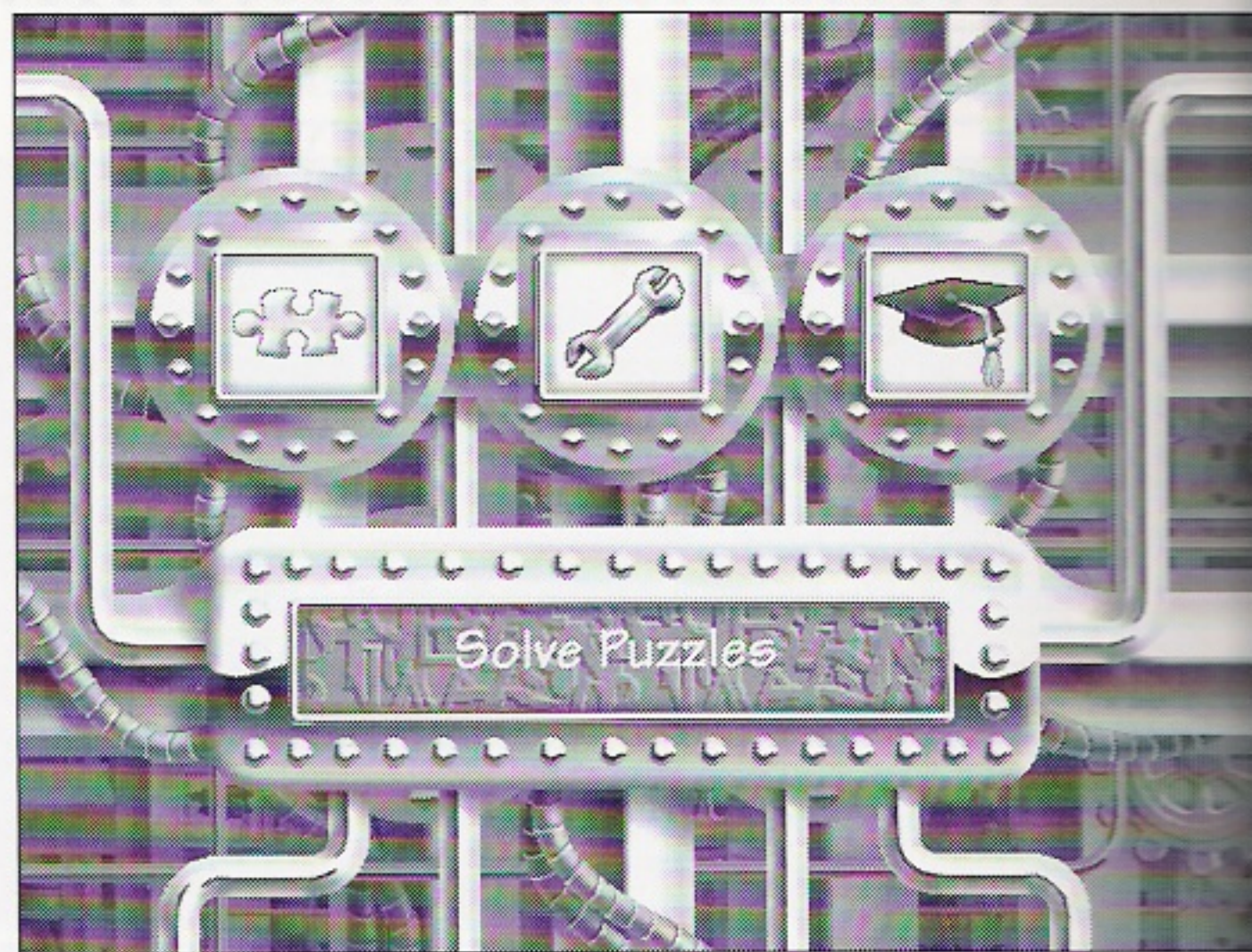

Move through the three options using the Directional Pad on the 3DO Controller™. Hit the A Button to choose the highlighted icon. You can return to this menu from anywhere in the game by choosing the exit doors on any menu.



PUZZLE PLAY

Choose this icon to go into Puzzle Play. There are 208 puzzles of varying difficulty for you to solve. Hitting this icon will take you directly to the first unsolved puzzle. See the Puzzle Play section on the next few pages for a full description.



MAKE A MACHINE

Takes you to Make A Machine, where you can build your own machines and puzzles from a bin of 60 parts. See the Make A Machine section on pages 16-19 for a full description.



TUTORIAL

Select this icon to go to the Tutorial Puzzles. This is a great place to start playing *The Incredible Machine*. Discover how various parts work while you solve beginning-level puzzles. See the Tutorial section on page 21 for a full description.

Puzzle Play Area

Playfield

Hand Cursor

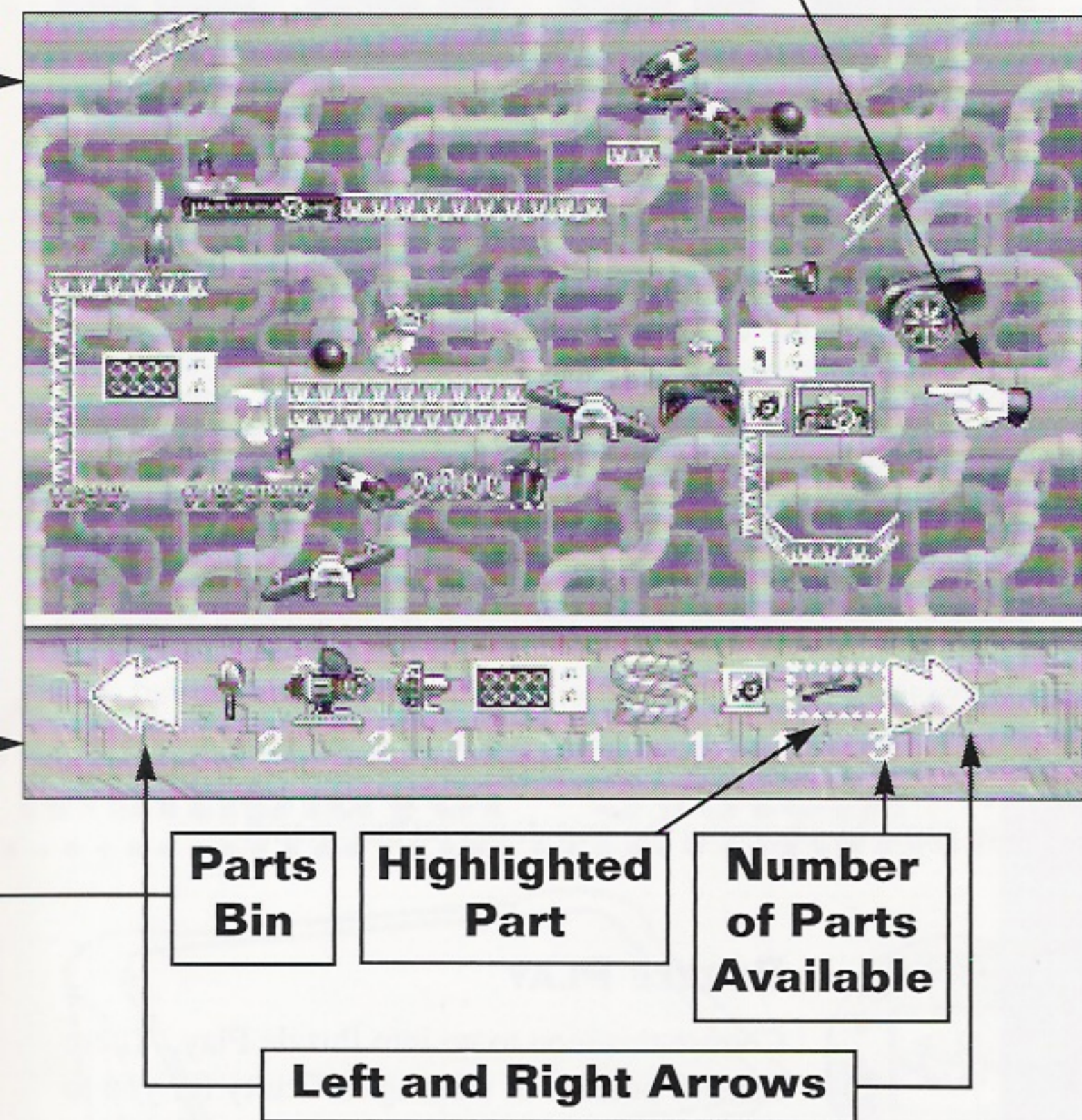

Playfield - Where all the action takes place.

Parts Bin - A panel of all the parts available for this puzzle.

The Parts Bin often extends beyond the screen, in which case you'll have to scroll to the left or right of the bin to see the full inventory. To do so, click on the yellow arrows pointing left and right.

Left and Right Arrows - These let you see extra parts that can't fit in the Parts Bin. You can also use the Left and Right shift buttons on the 3DO controller to scroll through the Parts Bin.

Hand Cursor - Move this around using the Directional Pad. See page 6 for a full explanation of Hand Cursors.

Highlighted Part - Shows that the belt is the active part in this puzzle. If you hit the A Button, the highlighted part will move onto the playfield and attach to the Hand Cursor.

Number of Parts Available - This indicates 3 belts are still available to be used in this particular puzzle.

SOLVING PUZZLE #1

1. Choose the Puzzle Play icon in the Opening Menu.
2. A goal screen for Puzzle #1 appears. Hit the A Button when you understand the goal.
3. The playfield appears with a puzzle awaiting your solution.
4. Test the puzzle to see what happens before you add any parts. Hit the C Button to bring up the Main Control Panel. Then hit the A Button to choose the lit-up green arrow. The Parts Bin will disappear and the puzzle will run. You can do this at any time while you're trying to solve a puzzle.
5. Hit the A, B, or C Button to stop the test run and to bring back the Parts Bin.

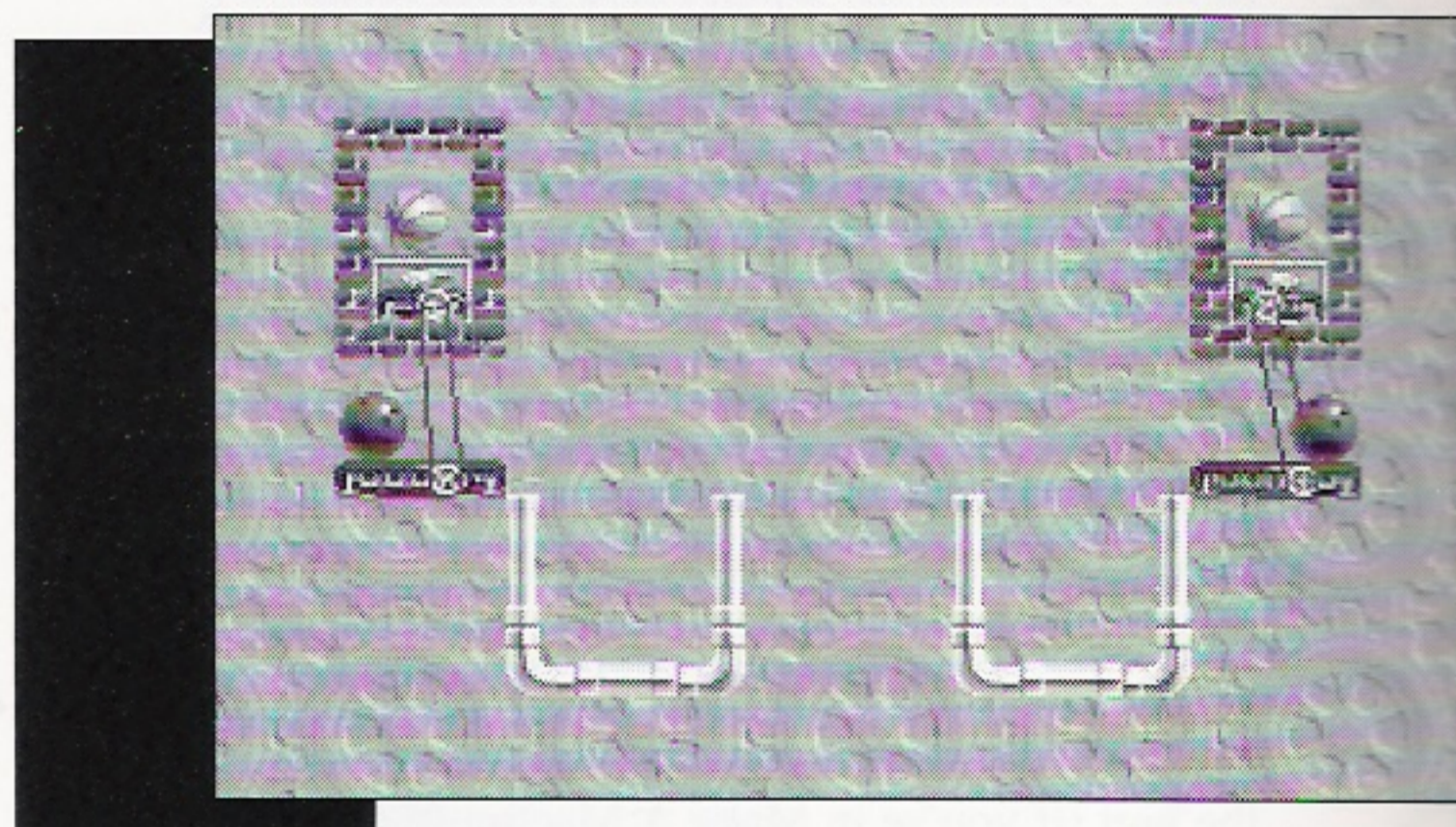

6. Position a mouse motor in the brick box on the right. Copy the example on the left.
7. Now you must *flip* the mouse motor. Move the cursor over the mouse motor. A question mark will appear. Hit the B Button to bring up the B Button Menu. Hit the red curved arrows icon to flip the part.
8. Connect a belt from the conveyor belt to the mouse motor. See page 6 for more info about belts.
9. Place the basketball above the mouse motor. The mouse motor, belt, and basketball should be set up just like the example on the right in the above picture.
10. Hit the C Button to bring up the C Button Menu.
11. Hit the A Button to choose the lit-up green arrow. The puzzle will run. You have solved the puzzle.

HELPING HAND CURSORS

Pointing Finger

Place this cursor over any part you want to pick up. A red question mark will appear when you have "touched" the part, and the part will be circled by a white highlight. Hit the A Button to pick up and move the part or hit the B Button to manipulate the part.

Quick Tip- If the Hand Cursor is not selecting anything on the playfield, a part will be highlighted in the Parts Bin. You can browse through the Parts Bin using the left and right shift buttons on the controller. Once the part you want to use is highlighted, hit the A Button and the part will jump from the Parts Bin to the Hand Cursor.

Open Hand

In the Playfield, the Open Hand cursor means you have picked up a part. In the Parts Bin, it means you can choose a part. You can now use the Directional Pad to move the part wherever you want it. Hit the A Button again to set it down.

Red Question Mark

This cursor asks you to choose between the A, B, and C Buttons. Choose A to pick up the part and make it active. The Open Hand icon will appear. Choose B to see the B Button Menu to flip, stretch, put back the part, or lock the part (if you're in Make A Machine). Choose C to get the C Button Menu. See page 10 for info on C Button options.

Belt and Rope Fingers

Ropes and belts can be moved around on the screen with the Pointing Finger cursor. As soon as the rope or belt is over a part to which it can be attached, the finger will shift to a horizontal position and the rope or belt will change from red to green. Hit the A Button to attach one end. Then stretch the rope or belt and hitch the other end to a second part. See page 22 for more details on ropes and belts.

Can't Attach

Can Attach



3DO

3DO™ Controller

SHIFT BUTTONS

Use the shift buttons to move the highlight left and right through any Parts Bin. Then select the highlighted part by hitting the A Button. The Shift Buttons work only when the Hand Cursor is in the Playfield.

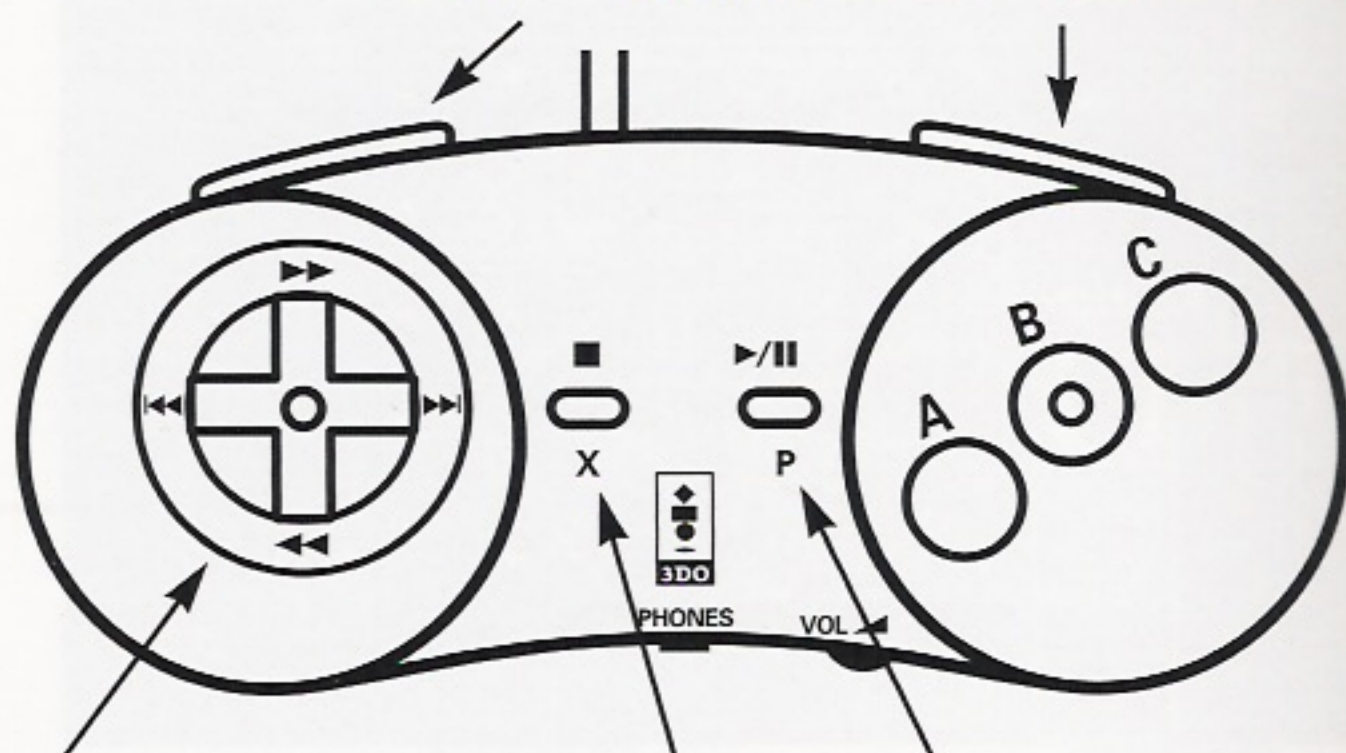

DIRECTIONAL PAD

Move the cursor in four directions. Scroll the screen in four directions. Move the active part (highlighted in green) anywhere on the Playfield.

STOP BUTTON

Quit the game.

PLAY/PAUSE BUTTON

Bring up either the Puzzle Play or Make A Machine Menu.

A BUTTON

THE A BUTTON IS THE PRIMARY BUTTON ON THE CONTROL PAD.

Press this button to:

- Choose any lit up selection from any menu.
- Bring any white highlighted part from the Parts Bin onto the Playfield.
- Place any part on the Playfield.
- Choose any highlighted icon from any menu.
- Stop any puzzle or machine that's in operation.

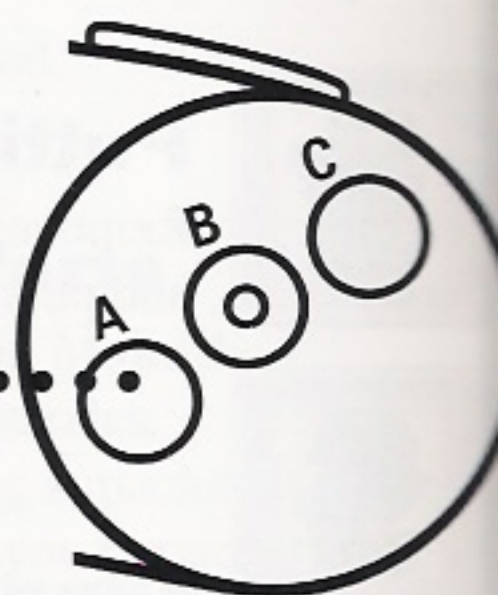

B BUTTON

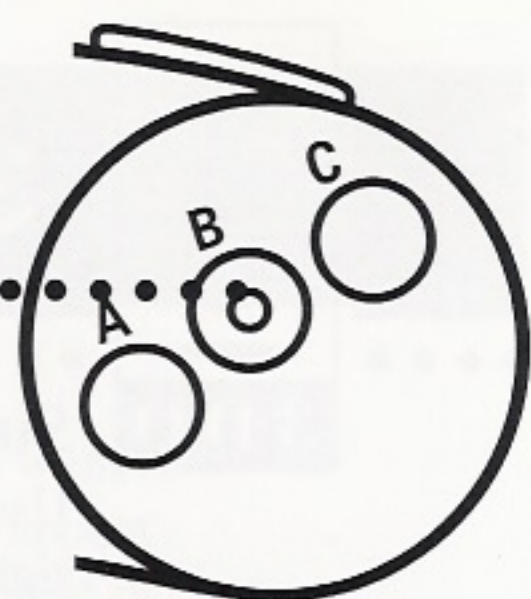

Active Part

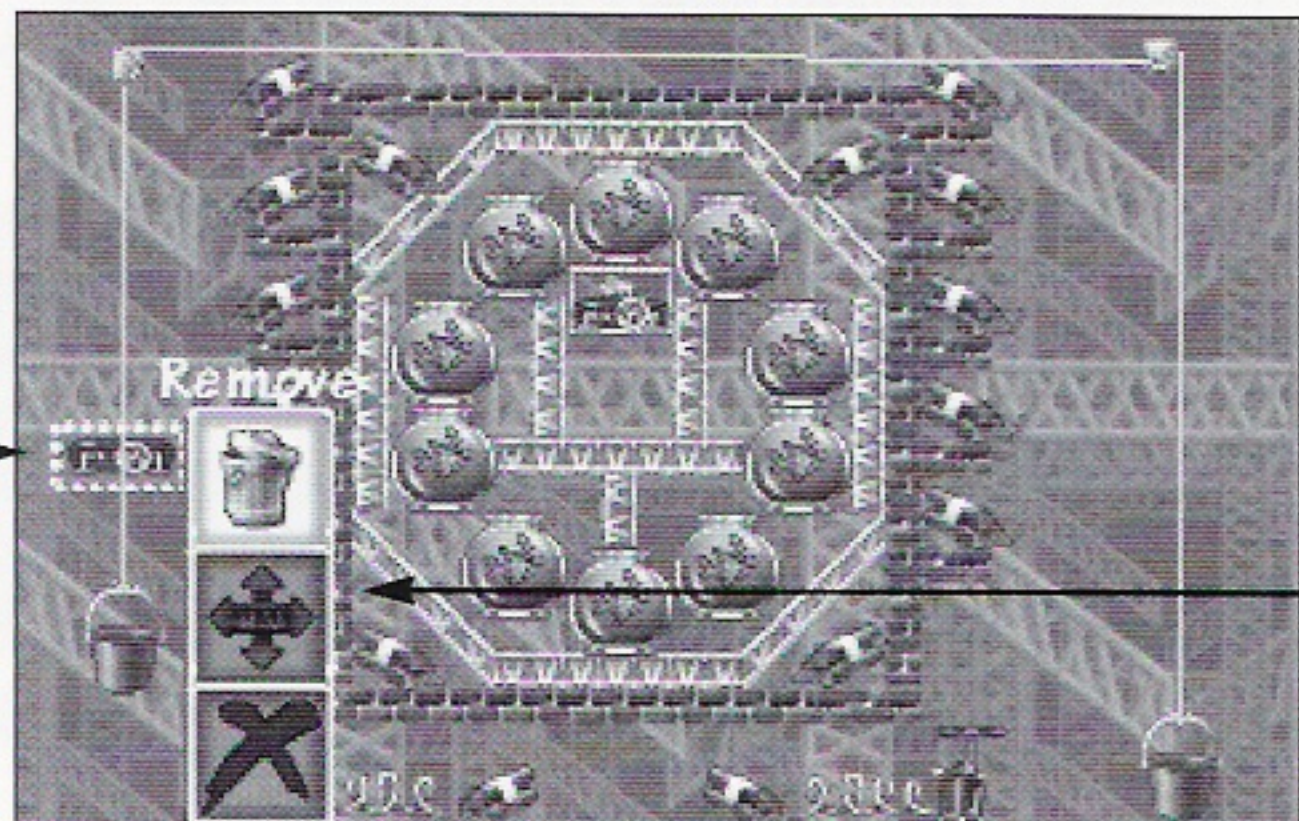

B Button Menu:

Hit this button to see the B Button Menu for any part on the Playfield. The part must be "active" (circled by a white highlight and displaying the red question mark).

Scroll through the icons using the Directional Pad. Then choose the highlighted icon by pressing the A Button.



Putting a Part Away

Removes the part from the Playfield and puts it back into the Parts Bin.

Flipping a Part

You can flip all sorts of parts to change the direction they're facing—including fans, inclines, guns, Ernie the Alligator, Mel Schlemming, Pokey the Cat, Mort the Mouse, and many others. From the B Button Menu of the selected part, choose the curving red arrows. Most parts will flip immediately. Some parts, such as the incline or the curved pipe, will offer you a second set of icons. Choose the arrows indicating the direction in which you want the part to flip.



Stretching & Shrinking Parts

All walls, conveyors, and inclines can be stretched or shrunk, but only so far. Walls can be stretched left and right, or up and down. Inclines change angles when they're stretched or shrunk. How do you do this?

1. From the B Button Menu of the selected part, choose the *four-way arrows*.
2. The B Menu will disappear and large blue arrows will appear on four sides of the selected part. Use the Directional Pad to highlight the desired direction for stretching or shrinking. Then hit the A Button.



3. The large arrows will disappear and a small arrow will appear at the end you've chosen to alter. Move the cursor over the arrow and stretch the part using the Directional Pad.



4. Hit the A Button when you're finished.



Locking Down Parts

The lock icon appears only in *Make A Machine*, not in any of the puzzles.

Use it to lock a part in place before saving a machine for others to play. Or use it to unlock a part you previously locked down. When you attempt to move a locked part, a closed padlock icon will appear. If you choose the closed padlock icon and hit the A Button, the part will unlock.



Cancel. Exit this menu.

C BUTTON

Press this button to bring up the C Button Menu. Scroll through the icons using the Directional Pad. Then choose the highlighted icon by pressing the A Button.

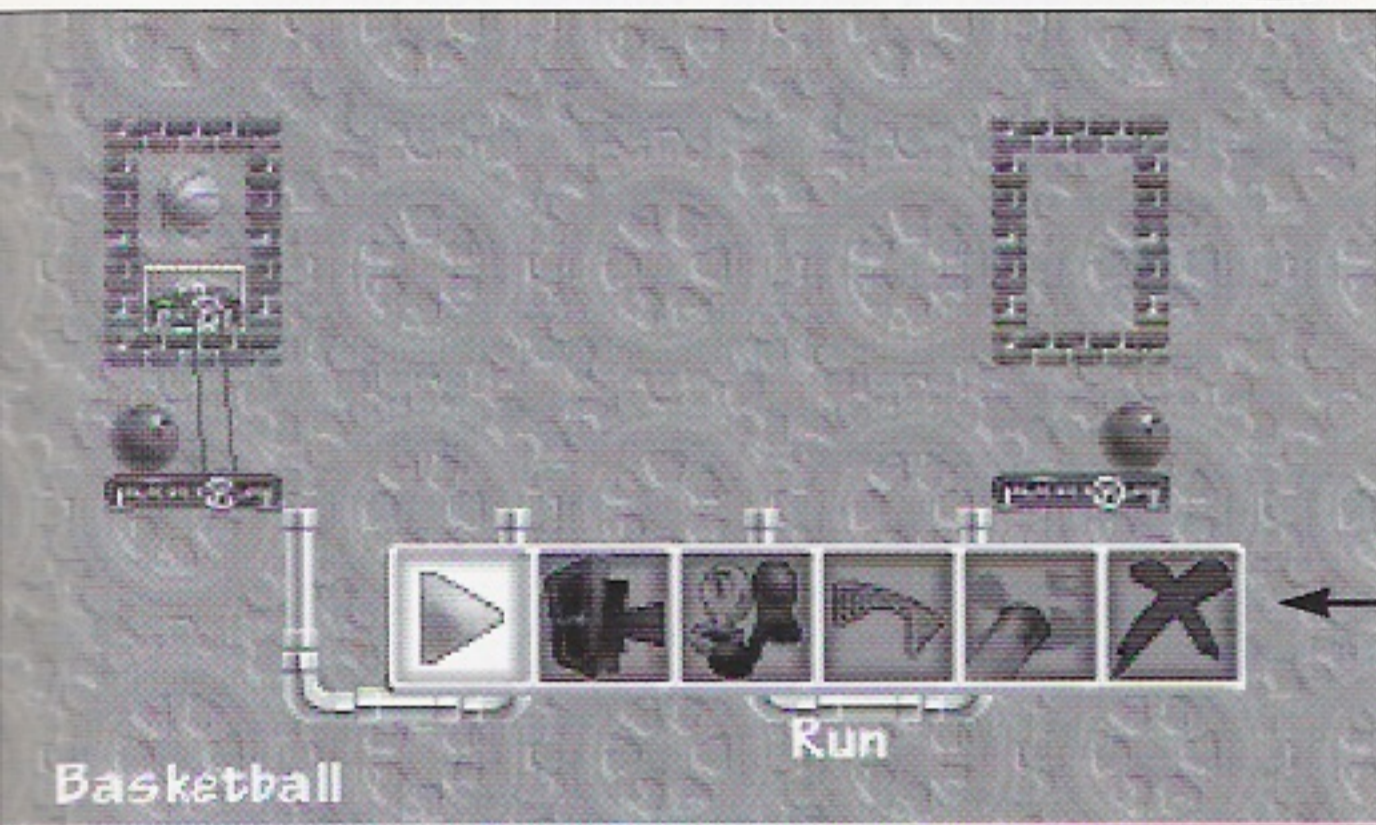
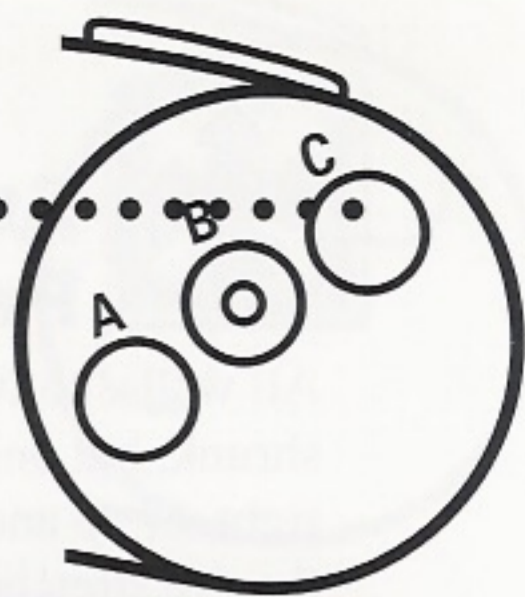

C Button Menu:

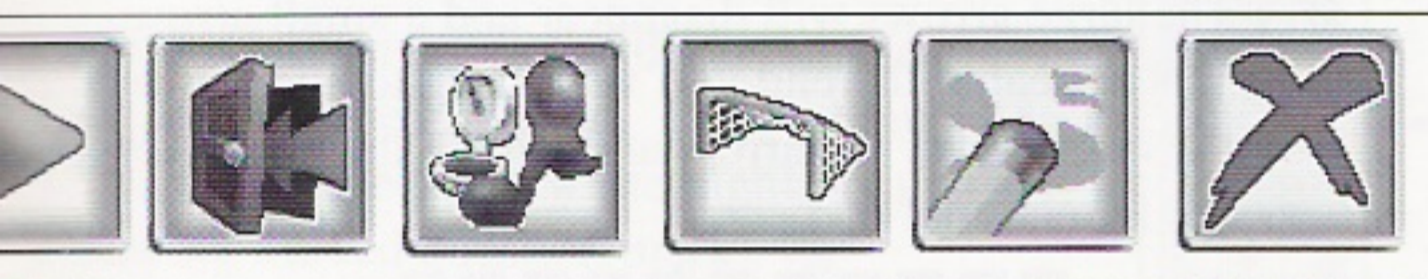

This is the Run button. It starts the puzzle.



Exit to the previous menu.



Brings up the Customizing Menu. This menu allows you to change music choices and choose to shut off the written goal descriptions and Help text. This will also shut off the Help text for all the menus except the Opening Menu. You can alter gravity and air pressure in Make A Machine. See page 14 for full info on the Customizing Menu.



Brings up the puzzle's goal. The player may read or hear the instructions for the puzzle as many times as necessary.



Clears all parts you have put on the screen and places them back in the Parts Bin.



Cancel. Exit this menu.

SHORT CUTS & HELPFUL HINTS

To Make Things Happen — Hit the A Button to set any choice into *action*. For instance, hit the A Button to choose any highlighted icon in any menu.

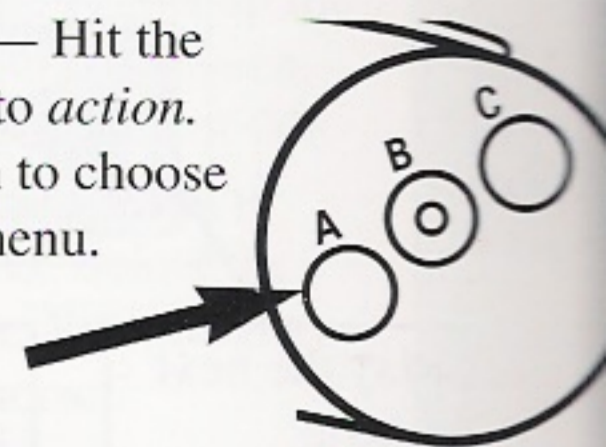

Grab that part! — You don't need to go to the Parts Bin every time you need a part. Just use the *Speed Toggling* method described below to highlight the part you want from the Parts Bin, then hit the A Button. The part will jump from the Parts Bin to wherever the Hand Cursor is located on the Playfield.

Speed Toggling — Any time there is no active part (no highlighted part) and the Hand Cursor is on the Playfield, you can toggle through the Parts Bin using the left and right shift buttons on the 3DO Controller.

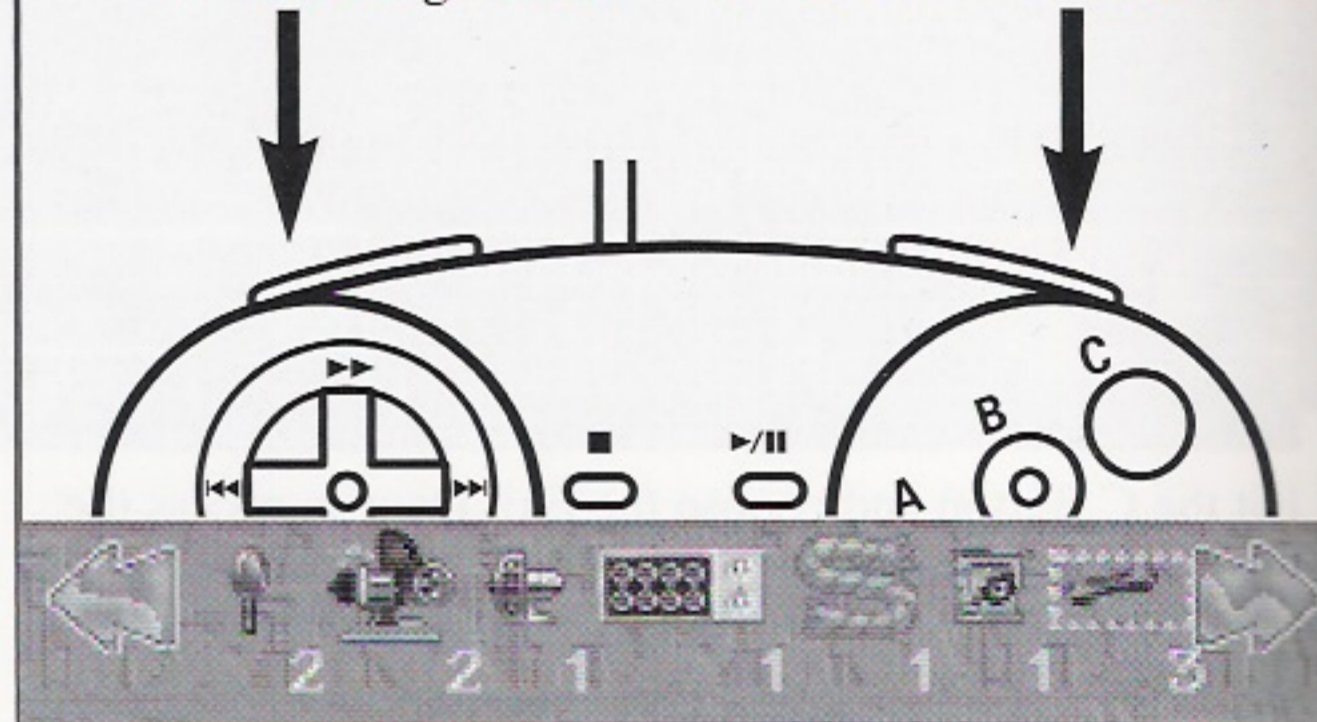

Those Sneaky Scrolling Puzzles — If a puzzle looks like it's not all there, it's probably a scrolling puzzle. Move the cursor off the right or bottom edge of the screen to reveal the hidden part of the puzzle.

How Does This Darn Part Work? — If a part (or combination of parts) seems a little confusing, check out the Tutorial Puzzle named after that part.

PUZZLE SOLVED MENU

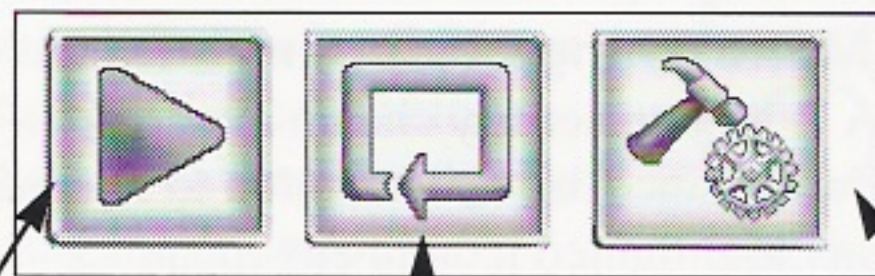

Play the next puzzle.

Replay the puzzle solution.

Return to the same puzzle and attempt a different solution.

PUZZLE PLAY MENU

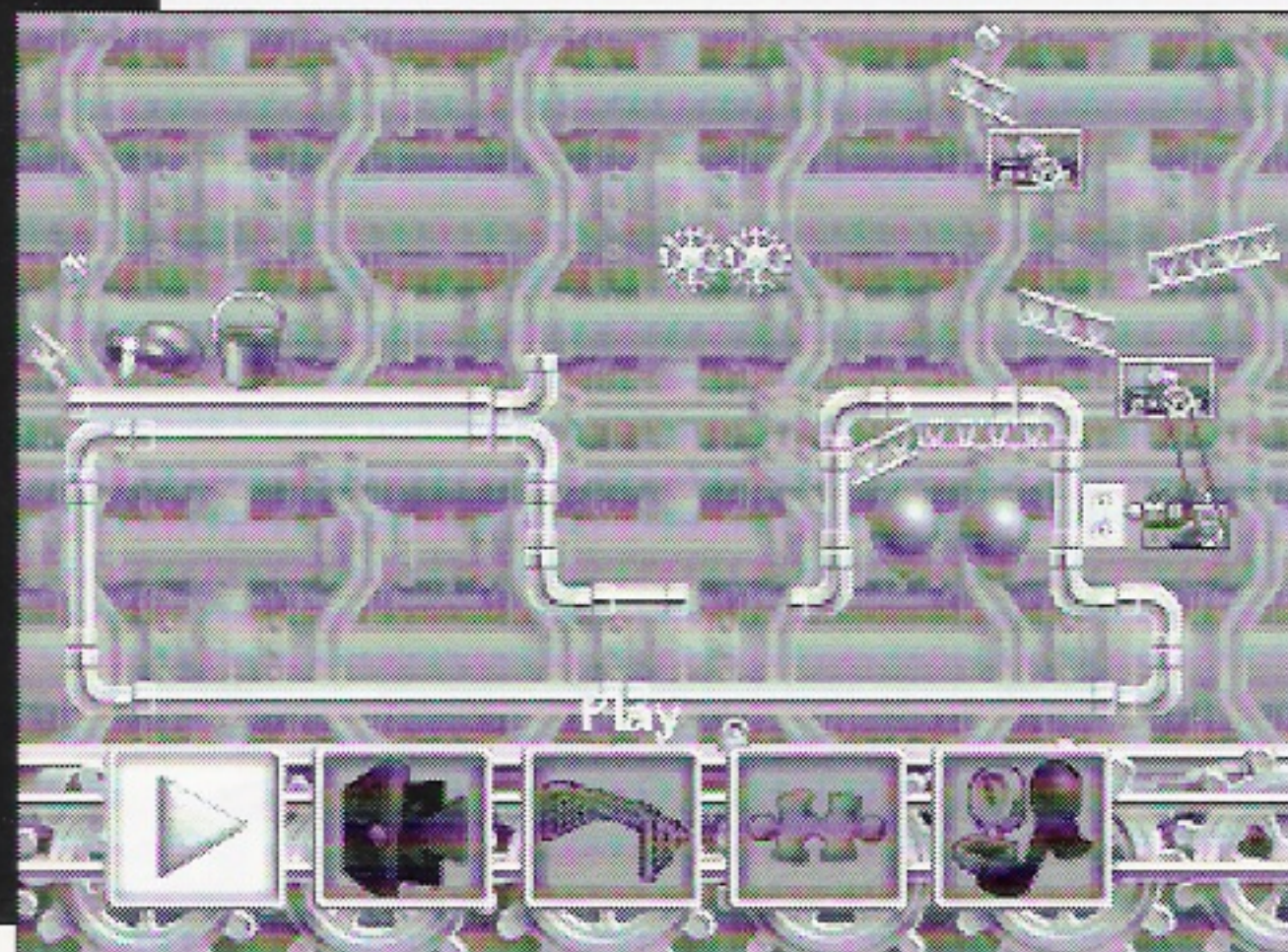

Hit the C Button and choose the Exit Door to access the Puzzle Play Menu.



The Play arrow takes you back into the game. You'll return to the last puzzle you were working on.



Takes you back to the Opening Menu.

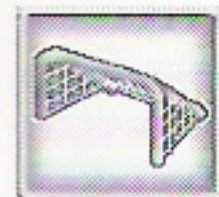

Brings up the text and voice goal of the puzzle you're working on (unless the text is turned off.)



Select this to see a complete list of puzzles you can choose from.



Choose this icon to go to the Customizing Menu, where you can change music, turn Help text on and off, and view gravity and air pressure.

SELECTING PUZZLES

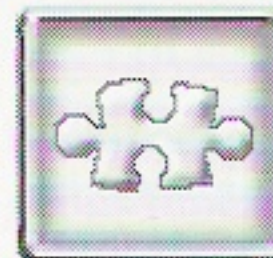

Selecting the Puzzle Play icon brings up the Puzzle Selection screen. From this screen, you can select a puzzle from the list of 208 puzzles. Scroll through the list using the directional arrows on the 3DO Controller. Select the highlighted title by hitting the A Button. You can play any puzzle you like in any order you choose.

NOTE: The puzzles get tougher the farther down the list you go.



SCROLLING PUZZLES

There are 20 scrolling puzzles scattered in with the Puzzle Play options. These puzzles are about four screens large, and will scroll automatically to follow the action. You can also scroll manually using the Directional Pad. Just move the cursor off the edge of the screen in any direction. To scroll left and right, you have to keep the cursor above the Parts Bin.

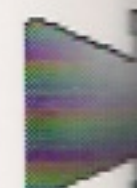

Customizing Menu



In Puzzle Play, this menu allows you to change the music and decide whether or not you want spoken puzzle goals in addition to the written instructions. In Make A Machine, you can change any of the atmospheric conditions in the puzzle you're working on. In Puzzle Play, you can only view the atmospheric conditions in the puzzle.

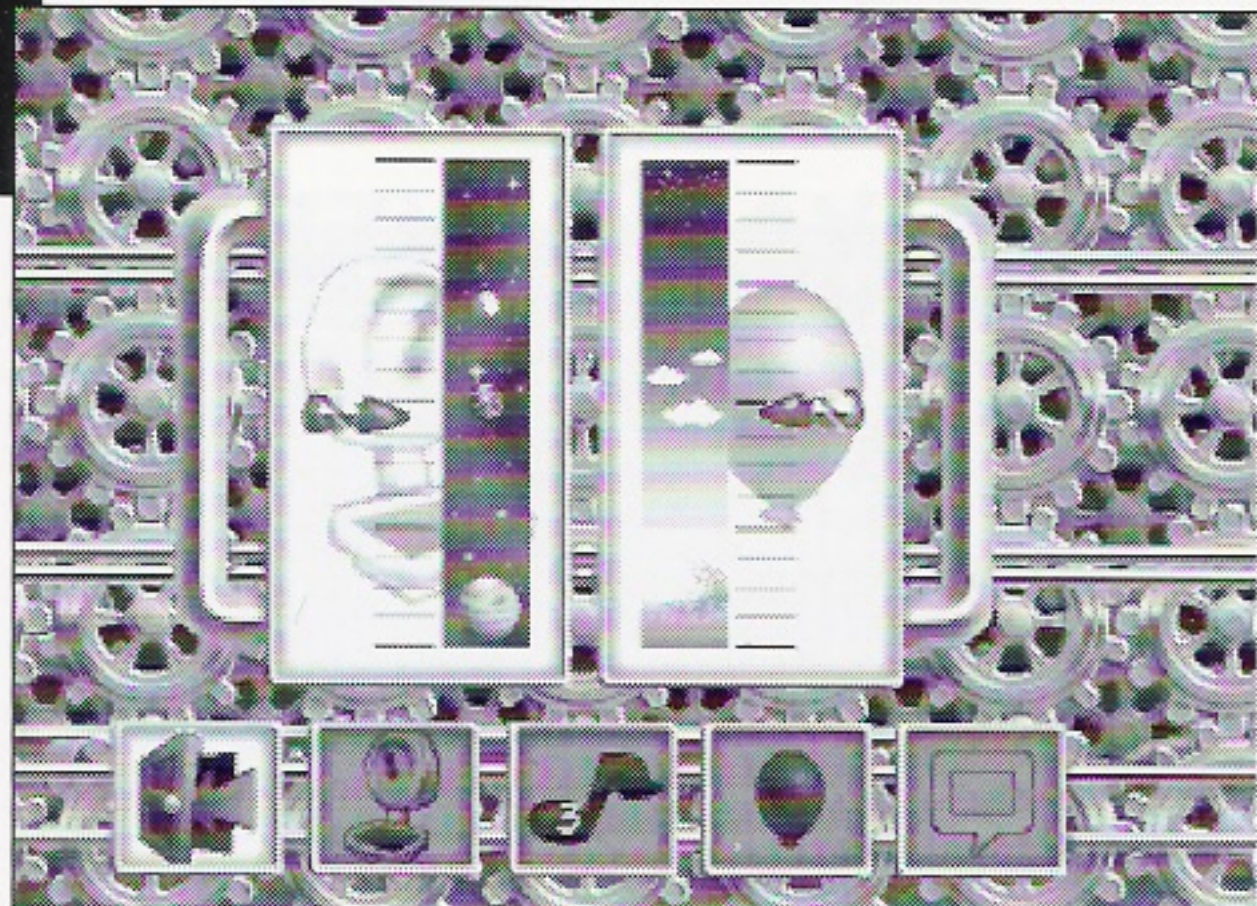

Choose the Exit Door once you've made the adjustments you want for your puzzle. These changes will be saved only for the puzzle you are presently working on, except the Crossed-out Conversation Bubble in Make A Machine. See below for more info.



Choose the Scale if you want to change the gravity in the machine you're building in Make A Machine. Use the Directional Pad to move the red arrow on the left up or down. You can only view this in Puzzle Play.



The Blue Note icon will take you to a Juke Box screen where you can choose the music you want to accompany the puzzle you're trying to solve—or the machine you're presently building. The small number appearing over the blue note indicates the Juke Box selection for the active puzzle. For more info on the Juke Box screen, see page 15.



Select the Balloon to change the air pressure in the machine you're building. Use the Directional Pad to move the red arrow on the right up or down. You can only view this in Puzzle Play.



When the Conversation Bubble is shown, you will get Help text and receive both written and verbal goals for the puzzles you're solving or building.



When the Crossed-out Conversation Bubble is shown, you get voice-only puzzle goals and no Help text. In Make A Machine, the goal text will always come up.

JUKEBOX SCREEN

The Incredible Machine Juke Box is loaded with 21 outrageous tunes—ranging from rock 'n roll to Cajun Zydeco. From the Customizing Menu, choose the Blue Note icon. That will bring up the Juke Box screen. Then you can choose from the following options:



Toggle *down* through the list of musical choices using the up/down arrows on the Directional Pad. To make a selection, hit the A Button. Allow about 5 seconds for the new music to load and begin playing.



Toggle *up* through the list of musical choices. Hit the A Button to make a selection as when using the other arrow.



This is your Auto-Tuner Option icon. When the red circle and slash are present, the active puzzle is locked in on the selection number at the top of the Juke Box. Highlight the icon and hit the A Button to switch over to Auto-Tuner. This will allow the Juke Box to automatically go to the next musical selection at the end of each tune—an especially welcome option if you're stuck on a puzzle for a long time.



Exit to the previous screen.

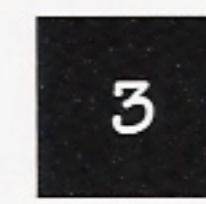

This indicates the type of music selected.

MUSIC SELECTIONS

- | | | |
|---------------------|---------------|-----------------|
| 1. Title track | 8. Blues | 15. Jazz Fusion |
| 2. European | 9. Classical | 16. Heavy Metal |
| 3. Funk | 10. Salsa | 17. Caribbean |
| 4. Reggae | 11. Polka | 18. Detective |
| 5. Cajun Zydeco | 12. Jazz | 19. Big Band |
| 6. Rock | 13. Soft Rock | 20. African |
| 7. Country/ Western | 14. Romantic | 21. Middle East |



Make A Machine Area

In Make A Machine, you're set free to design your own puzzles and machines. A full Parts Bin of 60 gadgets is at your disposal. Use your imagination. Anything goes. Once you've made something you want to show your pals and keep forever, you can give your puzzle a name and goal description, and save it in a special game file for future use. See page 19 for a full explanation.

A puzzle is simply a machine with a few parts taken away. The person playing the puzzle has to figure out what goes where in order to make the machine work. Here's how it's done:

TO MAKE A MACHINE

1. Choose the Wrench from the Opening Menu.
2. The Make A Machine Menu appears. Hit the A Button to choose the lit-up green arrow.
3. A blank Playfield appears with a full Parts Bin at the bottom of the screen. Use the left and right shifts on the controller to toggle through the Parts Bin. You have 60 parts at your disposal.
4. Use the A Button to select the part highlighted in white. Once the part is on the screen, move it into position using the Directional Pad. You can flip, lock, stretch, or put back the active part using the B Button Menu.

Make A Machine Menu

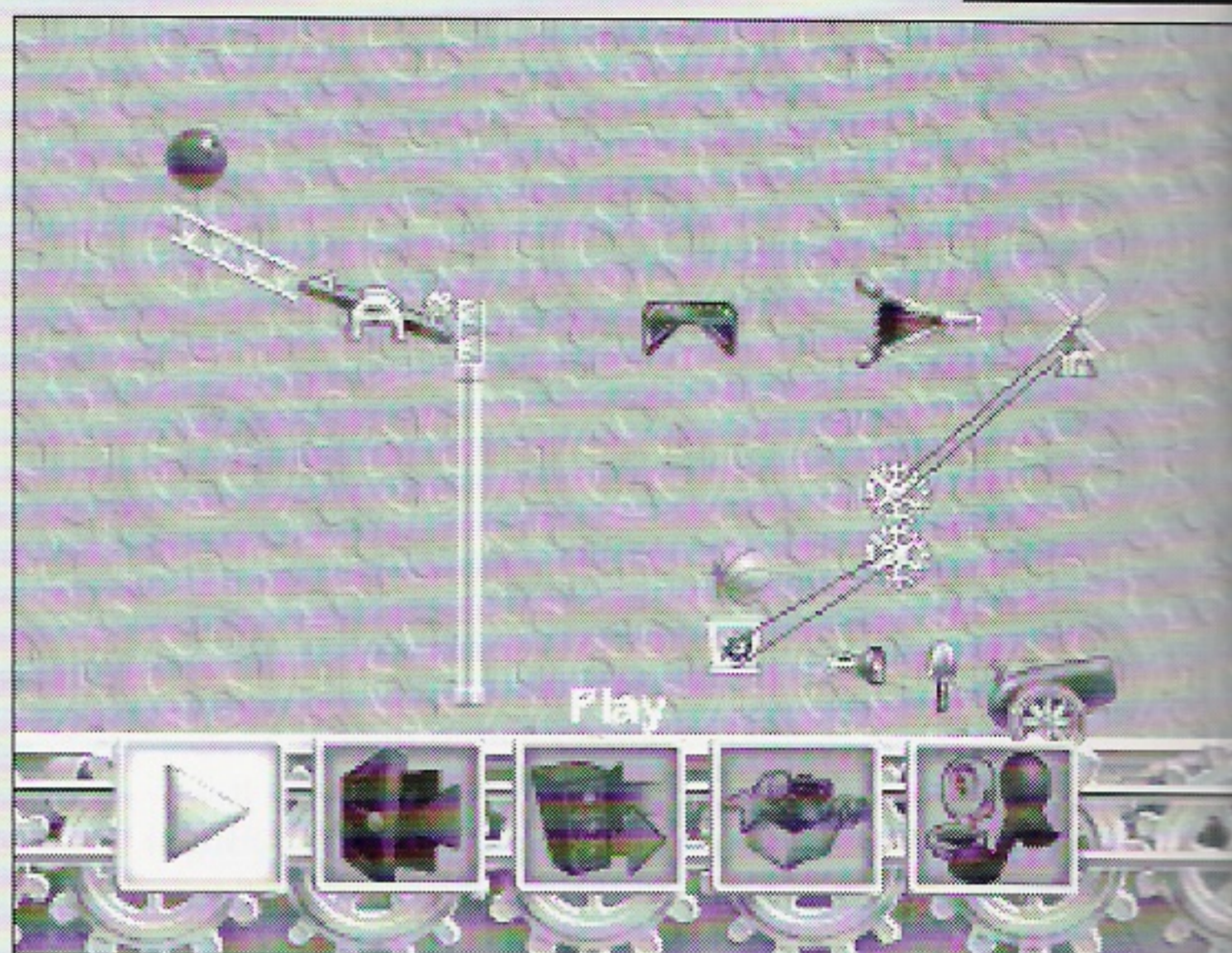

This menu shows up anytime you want to enter Make A Machine, or anytime you exit from a machine you're building in Make A Machine.



Takes you to a blank screen in Make A Machine, so you can start building a puzzle.



Takes you back to the Opening Menu.



Choose this icon if you want to *save* a machine you've been working on, or *load* a machine you previously built and saved. A new panel will appear so you can make your choices. See pages 19-20 for complete instructions on loading and saving puzzles.



This Box of Goodies takes you to the Parts Bin Editor, where you can control the contents of the Parts Bin for any machine you're building. See page for more info about the Parts Bin Editor.



This icon takes you to a separate menu where you can make adjustments to your machine's gravity, air pressure, and music. See page 14 for a full description of the Customizing Menu.

Parts Bin Editor

Once you've built an incredibly cool machine that you'd like to try out on your pals, you'll probably want to edit the contents of the Parts Bin and turn it into a full-blown puzzle. Here's how you do it:

1. From the C Button Menu, choose the exit door to go back to the Make A Machine Menu.
2. Choose the Box of Goodies icon to go to the Parts Bin Editor. 
3. From inside the Parts Bin Editor, hit the B Button to clear the Parts Bin in your new puzzle. **Note:** This cannot be undone.
4. Press the C Button to exit the Editor.
5. You'll be returned to your puzzle and the Parts Bin at the bottom of the screen will be empty.
6. Now lock down all the parts you don't want removed from your puzzle. Go to the B Button Menu and choose the Padlock icon for each part you want locked. The part must be highlighted in white to do this.

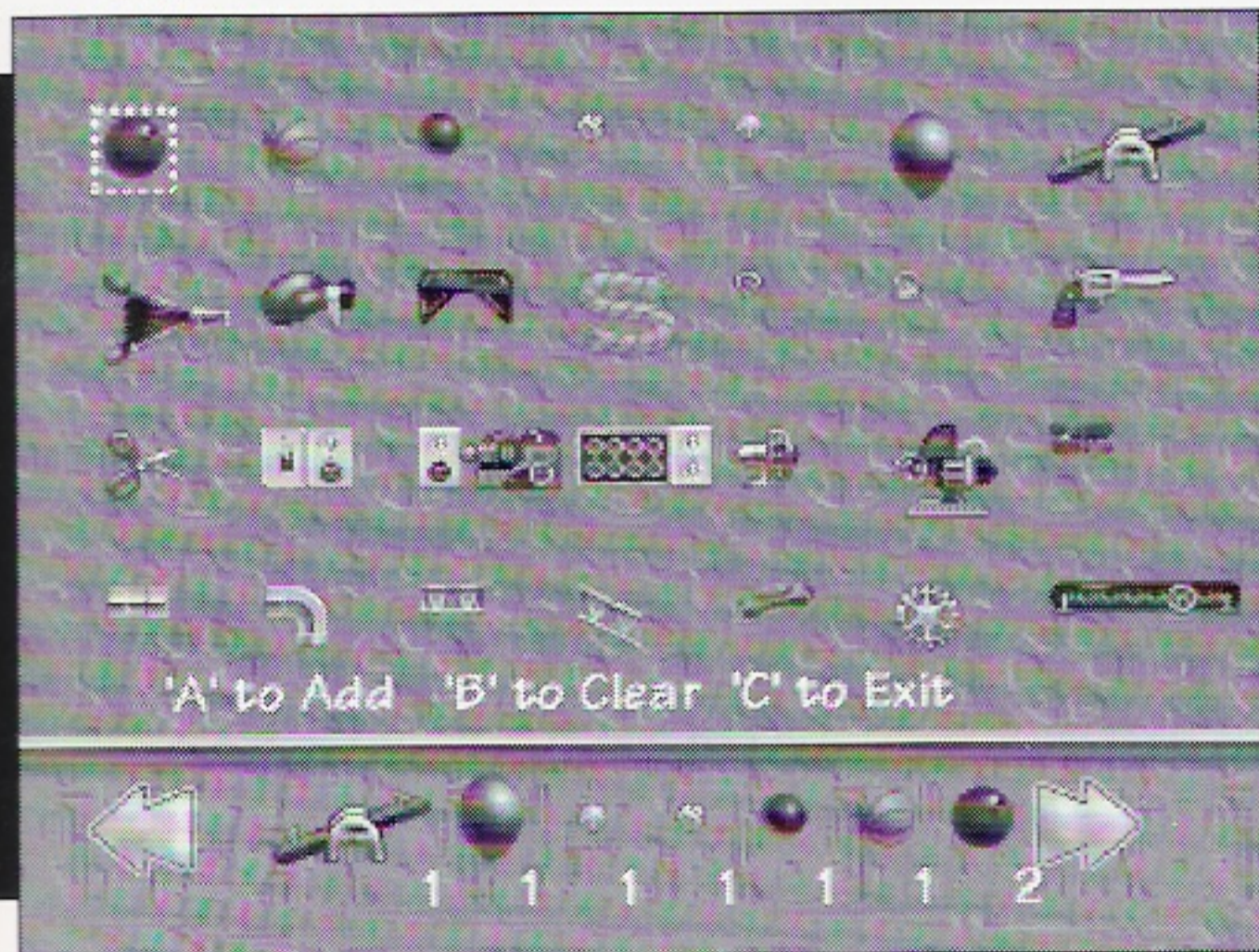

7. You'll also want to take a few parts out of your machine to turn it into a puzzle. The player will need to figure out where those parts go in order to solve the puzzle. Go to the B Button Menu and choose the Trash Can icon for each part you want dropped into the Parts Bin.

Make A Machine Note:

Solutions for Make A Machine puzzles are not recognized by the game. The player is on the honor system when solving a puzzle.

Save a Machine

You can save any machine or puzzle you're building at any time. If you get started on something and don't have time to finish it—no problem. Just save the machine as it is, and load it on again later to complete the job. You need to write a title, a goal, and a file name to save your work—each has its own screen. But it's easy to do:



1. From the Customizing Menu, choose the File Cabinet icon.
2. A Save/Load Menu will appear. Choose the File Drawer icon with the red arrow—this is the Save icon.
3. A screen with a virtual keyboard and a title box will appear. Use the Directional Pad to toggle through the keyboard. Select the highlighted letter or command by hitting the A Button. You may first want to select the RUB key to delete the word "title" from the box. You can write capital letters by holding down the left or right shift button while hitting the A Button for the highlighted letter. Once you've finished writing your title, choose END from the keyboard.



4. A Save Menu will appear. Choose the green arrow to continue saving. Choose the Exit Door to exit back to your machine without saving. Choose the Hammer and Gear if you decide you want to re-edit your title.
5. Use the same procedures you used in steps 3 and 4 to write and save a goal for your puzzle on the Machine Goal screen.
6. And finally, use the same approach to give your puzzle a file name in the third screen. Choose END when you're finished. Then hit the green arrow to return to your puzzle...which has now been saved. You can load it in from the Load screen whenever you want.

TO LOAD A PREVIOUSLY SAVED MACHINE

Make A Machine keeps a special file of the machines and puzzles you've created and saved. To load any of your previously created contraptions, just do the following:



1. From the Make A Machine Menu choose the File Cabinet icon.



2. From the Load/Save Menu, choose the File Drawer icon with the green arrow—this is the Load icon.

3. You'll be taken to the Load screen, which lists the file names of all the puzzles you previously saved. Use the Directional Pad to move up and down the list, then hit the A Button to choose the file name in white. Or choose the Exit Door if you change your mind about loading. The machine you selected will appear on the screen.

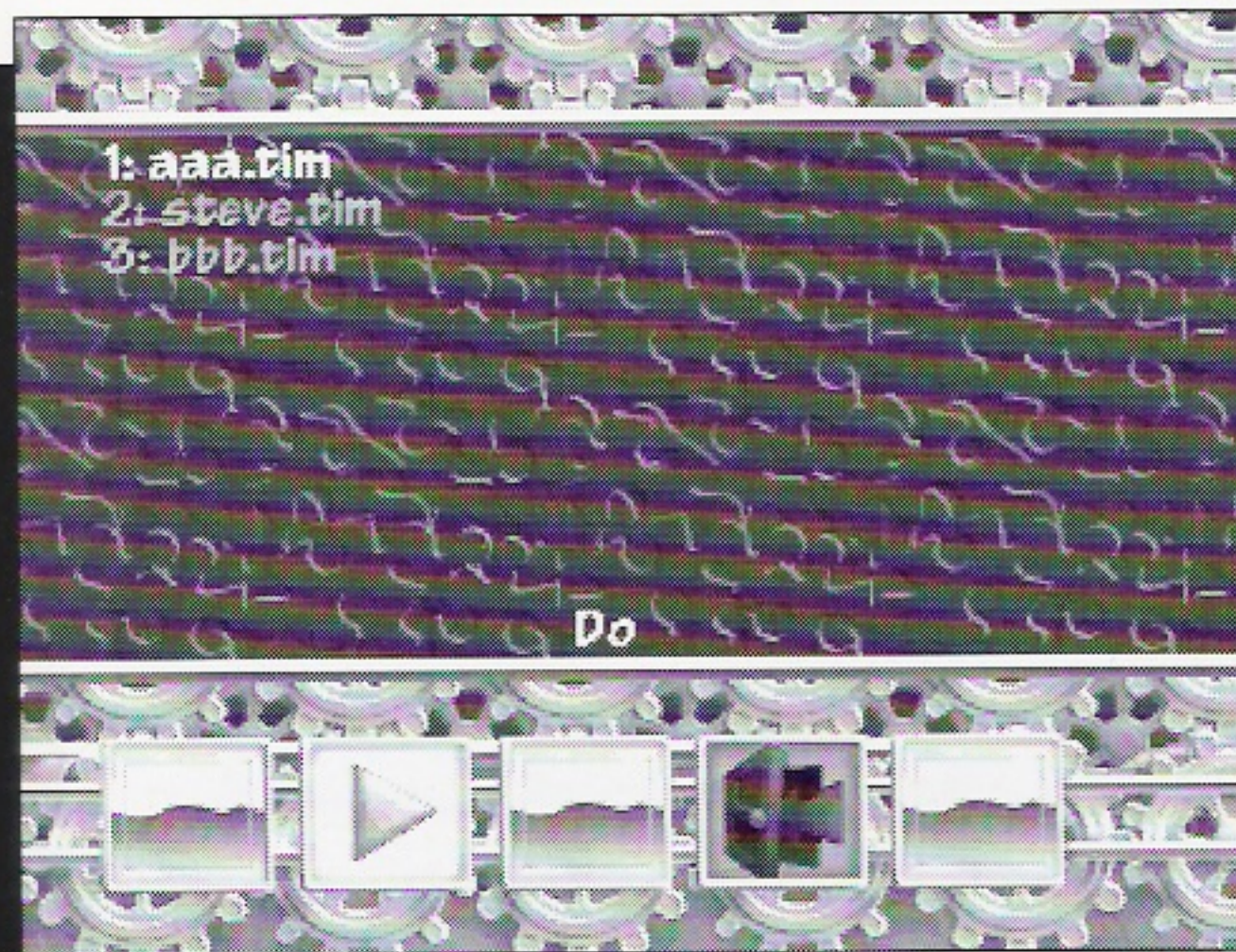

FILE ERROR MESSAGE!

If you're trying to load a puzzle you've just created and the "File Error" message comes up, you have too many files saved and you need to delete a file. To do this hit the A Button when the green Play arrow is highlighted. The Load screen will come up. Use the Directional Arrows to go through the list to a puzzle you want to delete. The puzzle titles will turn from green to white as you go down the list. Hit the A Button when the green Play arrow is highlighted to delete the highlighted puzzle. Hit the A Button with the Exit Door selected to return to the puzzle you want to save. Your puzzle is now saved. All puzzle titles have a .tim extension.

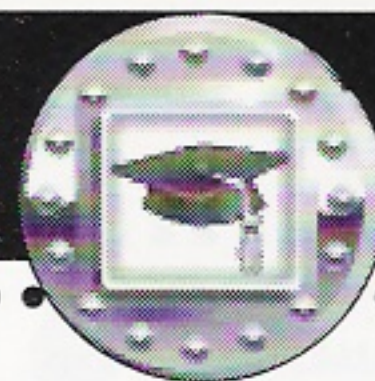

Tutorial Area

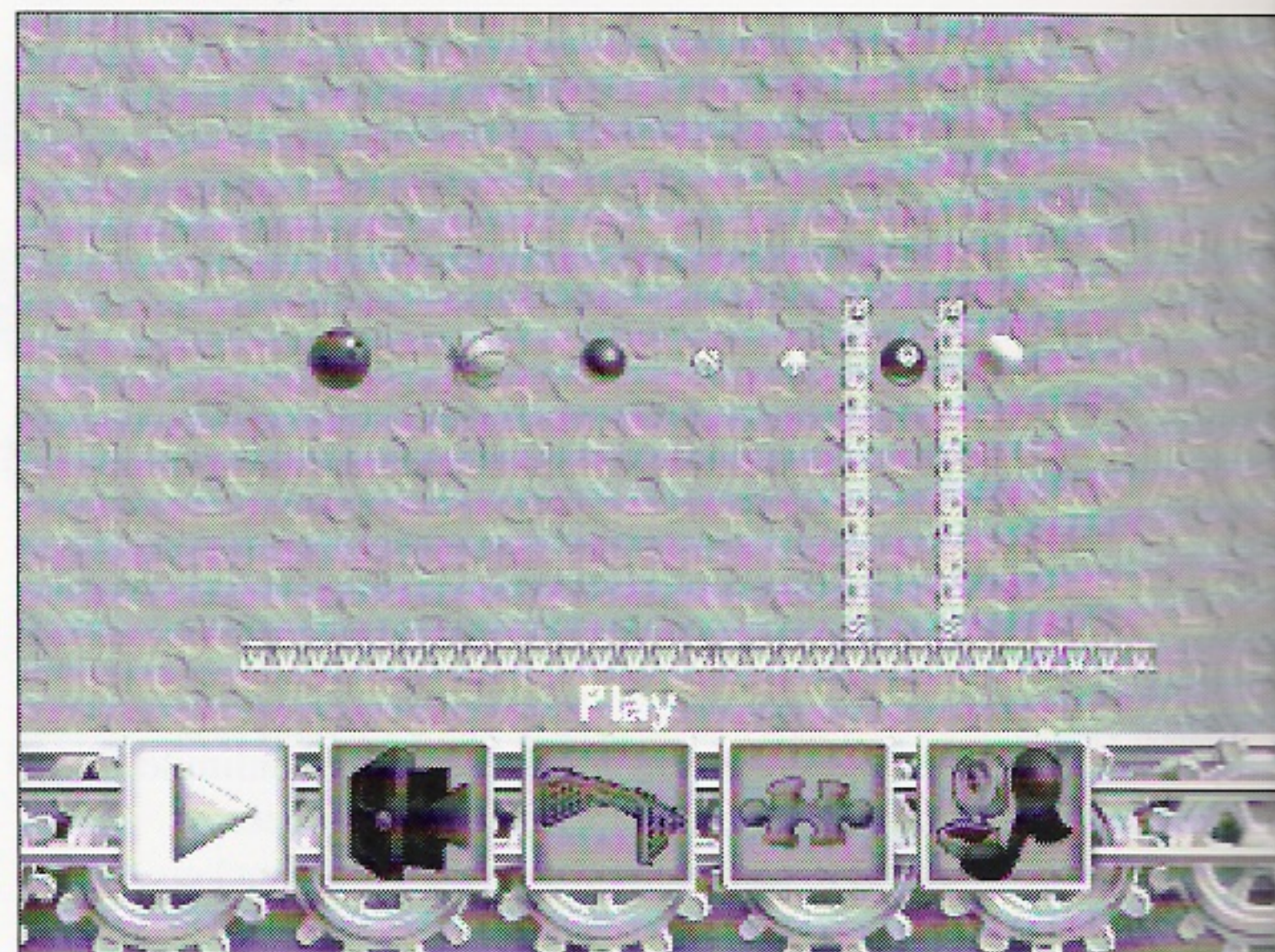

The Tutorial puzzles are the best place to begin your adventures inside *The Incredible Machine*. There are 30 introductory-level puzzles stashed away in here. They'll show you how various puzzle parts work, give you a chance to rig up simpler machines for yourself, and help you get used to the game's interface in a less mind-boggling environment. The Tutorials are also a good resource if you get hung up on a part in Puzzle Play (where most of the puzzles are a lot tougher). Each Tutorial puzzle is named after the part (or parts) being demonstrated in the puzzle's action.



BELTS

Belts may be used to connect any two “rotating parts.” For example, a mouse motor can be connected to a conveyor. Choose the Belt icon from the Parts Bin. Put the pointing finger cursor over the mouse motor and hit the A Button. If you are in the right place to attach the belt to the motor, the pointing finger will shift to a horizontal position. Hit A again to attach the belt. Then use the Directional Pad to stretch the belt over to the conveyor. When the pointing finger shifts horizontally, press the A Button again, and the belt will be attached. Other “rotating parts” include gears, windmills, generators, electric engines, monkey motors, conveyor belts and jack-in-the-boxes. Belts can only be stretched a short distance.



ROPES

Ropes are connected the same way as belts, but have unlimited length and may be stretched to any location on the screen. Ropes may be attached to any of the following parts: buckets, guns, teeter-totters, balloons, light bulbs, cages, and eyehooks.



PULLEYS

Pulleys can be used between any two parts which can be connected with ropes. The two parts must be on the screen before a rope can be run through the pulley. You can use pulleys for hoisting and lowering objects such as buckets, cages, and teeter-totters. You can run a rope through as many pulleys as you wish, but first you must attach one end of the rope to an object (such as a cage), then hit the A Button on each pulley you plan to use. Finally, you must tie the second end of the rope to another object (a bucket, for instance). Now the cage is tied to the bucket over a series of pulleys. If you drop a ball into the bucket, it will become heavier and pull the cage into the air.



POWER SUPPLIES

Some parts, such as the vacuum, require power. Place a power supply, such as a switch, on the Playfield. Place the vacuum next to the switch. If the vacuum has been plugged in, a plug will appear over one of the outlets attached to the switch. If a part has not been properly plugged in, the outlets will be empty and the part will not work when the machine is run. The switch always starts in the OFF position regardless of which way it is flipped. You must hit the switch with another object to flip it to the ON position.



NOTE: A power part will plug in only if you move it to a socket. You cannot move a plug to a power part: it will not connect.



BASEBALL — Responds to gravity. Doesn't bounce a whole lot.



BASKETBALL — Rolls, falls, and bounces prodigiously.



BOWLING BALL — Extremely heavy. Doesn't bounce.



EIGHT BALL — Will not roll until it's hit by another object, at which time it will move in a perfectly straight line until it bumps into something else or exits the screen. It's immune to the forces of gravity.



CANNON BALL — Extraordinarily heavy. Doesn't bounce.



SUPERBALL — Wildly unpredictable. Gains velocity with every bounce.



TENNIS BALL — Moderately bouncy.



BALLOON — Tie a rope to this balloon and use it to pull on the teeter-totter, shoot the gun, trigger the boxing glove, or push the bellows. It will pop if it makes contact with scissors, candles, rocket flames, nails, or moving gears. It's greatly affected by gravity and air pressure!



NAIL — Most useful for popping balloons. May also be arranged into steps for Mel Schlemming.



TEETER-TOTTER — Drop something heavy on it, or bump it from underneath to make it change inclines. Use a rope to tie either end of the teeter-totter to a balloon or heavy object. It also makes an excellent catapult: drop something heavy on the high end of the board and use it to hurl something into the air off the lower end.



BELLOWS — Blows air when you drop an object on the handle or bump up on the handle from underneath. Especially useful for moving balloons and blowing out candles.



BOXING GLOVE — Hit the button on the back end of the glove to trigger a spring-loaded punch. Useful for moving all sorts of objects, starting the mouse motor, and breaking the fish bowl.



TRAMPOLINE — Anything dropped on this trampoline bounces higher and higher with each contact.



ROPE — May be tied to teeter-totters, balloons, buckets, guns, cages, eyehooks, and monkey motors. May also be run through pulleys (as many as necessary) for raising and lowering objects. See the Ropes section on page 21 for more information.



EYE HOOK — Tie a piece of rope to this eye hook and use it to hang things in the air, or to keep balloons from drifting away.



PULLEY — Run a rope through it to hoist and lower things. See the Ropes section on page 22 for more information.



GUN — Tie one end of a rope to the trigger, and tie the other end to an object that will pull the rope. Pulleys are often helpful for this task. Will break the fish bowl, blow up dynamite, and knock objects out of the way.



SCISSORS — Drop something on the handles and use them to cut rope. Balloons will pop against the scissor tips.



LIGHT SWITCH AND SOCKET — A convenient source of electrical power. Plug something into the socket, then flip on the switch by hitting it with another object. Use it to power the electric engine, vacuum cleaner, or the electric fan. The switch and socket must be placed on the screen *before* you set down the object you wish to power. A tiny black plug will appear in the socket when this is done correctly. See the Power Supplies section on page 22 for more information.



GENERATOR — Use this to produce electrical energy from rotating parts (such as the mouse motor, the monkey motor, moving gears, and conveyor belts). Use a belt to connect it to the rotational part of your choice, then plug any electrical part into the generator's socket.



SOLAR PANEL — Collects light rays from the light bulb, flashlight, or candle, and changes them into electrical energy. Plug any electrical part into the solar panel's socket.



FAN — Plug it into an electrical outlet. Creates air currents that can be used to turn the windmill, blow out a candle, or push objects away.



VACUUM — Sucks up all sorts of things when plugged into an electrical outlet.



ELECTRIC ENGINE — Must be connected to an electrical outlet. Add a belt and use it to power rotational parts (like the windmill, conveyor belt, gears, or any object that uses a belt).



BRICK WALL — Stretch it left, right, up, or down. Dynamite will blast holes through it.



PIPE AND CURVED PIPE — May be stretched and flipped to create walls and floors of varying length. Curved pipe is useful for rounded corners. Dynamite has no effect on these parts.

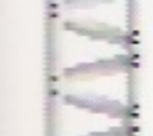

WOOD WALL — May be stretched in four directions like the other walls. Can be destroyed with dynamite.

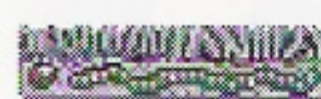

DIRT WALL — May be stretched in four directions like the other walls. Things don't bounce, roll, or slide very well on this surface. Dynamite has no effect on dirt walls. Dirt walls can't stretch horizontally or vertically.



INCLINE — Force objects to move up or down inclines. Inclines flip in either direction, and stretch to increase or decrease the angle. Dynamite-proof.



BELT — Attach it to motors, conveyors, gears, or windmills. Limited stretching distance. Only one belt may be used on each rotating part. See the Belts section on page 22 for more information.



GEARS — As many as necessary may be placed side to side or top to bottom. Make them rotate by connecting them to a rotating power supply (like the electric engine) with a belt. Each time a gear is placed against another, the direction of rotation is reversed.



CONVEYOR — Connect this to a rotating power supply (like the monkey motor) and use it to carry objects or drop things. It can be stretched.



JACK-IN-THE-BOX — Will pop open when connected to a rotating power supply with a belt. Place things on top of the box and make them fly into the air when the lid pops open. As with a real Jack-in-the-box, it takes a few turns of the handle before Jack pops out. This is a good part to use for tricky timing puzzles.



WINDMILL — Use the bellows or electric fan to make it turn. Add a belt and use it to power another rotating part. Flip it in the direction of the wind source to make it work.



MAGNIFYING GLASS — May be placed in front of any light source to ignite fuses. Needs to be flipped in the correct direction to work.



FLASHLIGHT — Drop something on the button to flick it on. Use it to power up a solar panel. Shine it into a magnifying lens to light the fuse of a rocket, cannon, or candle.



LIGHT BULB — Tie a rope to the string, then attach a heavy object—a bucket, for instance. When the bucket falls, the light will switch on. Use a light bulb to power up a solar panel. Or shine it through a magnifying lens and light a fuse.



CANNON — Use a candle, a rocket, or shine any light through a magnifying lens to light the cannon's fuse. Does not affect walls or inclines.



DYNAMITE — Light the fuse with a candle, rocket, or magnifying glass and light source. It blows holes in brick and wood walls, but not incline ramps or dirt walls.



ROCKET — Flies straight into the air when its fuse is lit by means of a candle, another rocket, or a magnifying glass and light source. It will light any part with a fuse or wick.



CANDLE — Light the wick with a rocket, another candle, or a magnifying glass and light source. A convenient tool for heating the teapot, or for lighting any object with a fuse.



TEAPOT — Place a candle under it and use the steam to push objects.



DYNAMITE PLUNGER — Drop something on top of the plunger to cause an explosion. It will blast through wood and brick walls, but not inclines or pipes.



BUCKET — Drop it on top of things. Knock it off walls. Put balls (or any part affected by gravity) inside it. Tie a rope to the handle and use pulleys to connect it to something you want to lift (a cage, for instance, or a teeter-totter), then drop something heavy into the bucket to force the reaction.



CAGE — Use it to catch Pokey the Cat, Mort the Mouse, or Mel Schlemming. Hang the cage from a rope, then cut the rope with a pair of scissors when the desired captive walks beneath it.



POKEY THE CAT — Aspires mainly to eat Mort the Mouse or Bob the Fish. He will chase Mort whenever he sees him. He will go after Bob whenever he's close to the fishbowl, or if the bowl gets broken.



MORT THE MOUSE — Pursues cheese. Runs from Pokey.



CHEESE — A high-cholesterol Colby. Mort's great passion in life.



MOUSE MOTOR — A vigorous rodent lives inside this cage. When the cage is bumped, he runs on his metal wheel and generates rotational energy. Attach a belt between this motor and any rotating part.



BOB THE FISH — Should his bowl happen to break while Pokey's around...Bob will be no more. Same thing if Pokey gets close enough to the fishbowl.



MONKEY MOTOR — Tie a rope to the shade and use another object to pull it open. When Kelly the Monkey sees the banana she begins to pedal in a Pavlovian frenzy. Attach a belt to the front wheel to power other rotating parts.



MEL SCHLEMMING — Mel walks mindlessly in a straight line, paying no attention at all to where he's headed. If he falls from too high a place... so much for Mel. He's also a favorite appetizer for Ernie the Alligator.



MEL'S HOUSE — Tract housing straight out of one of those suburban sitcoms of the Seventies. This is Mel's haven of safety.



ERNIE THE ALLIGATOR — Ernie will consume Mort the Mouse or Mel Schlemming with vigor and glee. Also acts as a catapult—whenever something is dropped onto his tail or snout, he'll flick it into the air.



PINBALL BUMPER — Balls and other objects that run into this bumper will be bounced off wildly in a random direction.

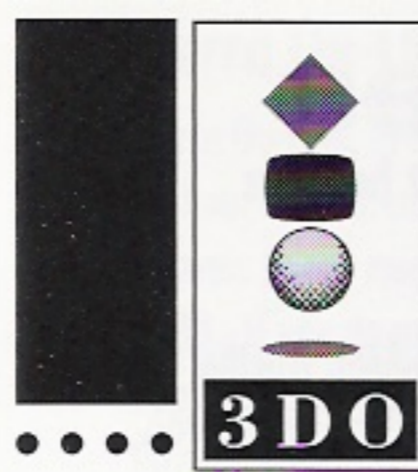

The Incredible Machine 3DO™ Game Credits

• PRODUCER
Jeff Tunnell

• ORIGINAL GAME DESIGN
Kevin Ryan

• DESIGNERS
Jeff Tunnell
Steve Letsom

• PROGRAMMER
Steve Letsom

• ART DIRECTOR
Kyle Miller

• PUZZLE DESIGN
Richard Tunnell

• WRITER
Michael Waite

• MUSIC & SOUND EFFECTS
Chris Stevens

• VOICE
Bill Barrett

• INTRODUCTION 3D ANIMATION
Cyrus Kanga

• QUALITY ASSURANCE
Corey Reese
Eli Haworth

• MANUAL DESIGN
Shawn Bird

• SPECIAL THANKS
Neil Day

Derek & Peter

3DO Developers
Support Group



another incredible
Jeff Tunnell
Production

Customer Services

The best customer service in the industry — "You don't just buy our games, you buy the support of the whole company."

Sierra On-Line is dedicated to helping you with each and every question or problem. Whether it's memory shortages, software compatibility, or any other issue affecting our products, we guarantee your satisfaction.

Customer Service

Contact the Customer Service Department, 1-800-SIERRA-5, for issues pertaining to returned merchandise, back orders, defective merchandise, and general game information.

U.S.

Sierra On-Line
Customer Support
P.O. Box 600
Coarsegold, CA 93614-0600

1-800-SIERRA-5 (1-800-743-7725)

EUROPE (U.K.)

Sierra On-Line Limited
4 Brewery Court
The Old Brewery
Theale, Reading, Berkshire
RG7 SAJ, United Kingdom
(44) 734 303171

TECHNICAL SUPPORT

Direct questions on hardware and software compatibility to the Technical Support Department. Call (206) 644-4343 in the U.S. or (44) 734 303171 in the U.K. for convenient, person-to-person technical assistance. If you prefer, you may contact Technical Support by Fax (209) 683-3633 in the U.S. or (44) 734 303362 in the U.K., or by mail. If you choose to write or fax us with your request, please give us detailed information on your computer system and the nature of your problem. In addition, please include your address and telephone number should we need further information.

U.S.

Sierra On-Line
P.O. Box 800
Coarsegold, CA 93614-0800
Attention: Technical Support

Monday-Friday, 8:15 a.m. - 4:45 p.m.
Call (206) 644-4343, Fax (209) 683-3633

EUROPE (U.K.)

Sierra On-Line Limited
Attention: Technical Support
4 Brewery Court,
The Old Brewery
Theale, Reading, Berkshire
RG7 SAJ, United Kingdom
Monday-Friday, 9:00 a.m. - 5:00 p.m.
Call (44) 734 303171, Fax (44) 734 303362

SIERRA TECHNICAL SUPPORT IS ALSO AVAILABLE THROUGH:

*Sierra BBS: U.S. (209) 683-4463 or U.K. (44) 734-304 227

CompuServe-GAMCPUB, Section 11 (Technical Support ID - 72662, 1174)

Prodigy (Technical Support ID - WBWW55B)

America OnLine (Keyword: SIERRA)

GEnie (Private E-mail SIERRA.SUP)

*Answers to our most frequently asked questions are available through our Sierra BBS (U.S. only). At the main menu, select option "8" for *Technical Help* and then select "T" for *Top 10 Technical Issues*.

Dynamix is also on CompuServe. Members of CompuServe can type GO GAMCPUB and leave a message for us at Dynamix (CIS ID 72662,1174). If you are not currently a member of CompuServe, call toll-free (800) 848-8199 and ask for Representative 461 for your FREE introductory membership and usage credit. In addition to receiving support for Dynamix games, you'll also find new demos, hints, and reviews of many Dynamix products as well.

Sierra On-Line's Automated "800" Technical Support Service

Sierra On-Line, in our commitment to provide the best Technical Support in the industry, offers a 24 hour automated Technical Support Line. Our automated Technical Support Representative has answers to our most frequently asked technical questions and is available by calling (800) 376-2683. If you do not find the answer to your specific technical issue, you can call our Technical Support Department at (206) 644-4343 and speak to a Technical Support Representative Monday through Friday, 8:15 a.m. - 4:45 p.m. Pacific Time.

In the U.K., although there is no automated voice response system at this time, technical answers to many questions are available on the Bulletin Board, (44) 734 304227. Or you may speak to a Technical Support Representative at (44) 734 303171 Monday through Friday, 9 a.m. to 5 p.m.

Orders

Order games, hint books or hardware, redeem coupons, use special discounts, or get a list of software dealers in your area where you can purchase Sierra games by calling 1-800-757-7707.

U.S.

Sierra On-Line
Sales Dept.
P.O. Box 978
Oakhurst, CA 93644-0978

For direct orders:

Call 1-800-757-7707, Fax (209) 683-4297

EUROPE (U.K.) orders:

Call (44) 734 303171, Fax (44) 734 303362

THE SIERRA NO RISK GUARANTEE!

THE PROMISE: We want you to be happy with every Sierra product you purchase from us — period. If for any reason you're unhappy with the product, return it within 30 days for an exchange or full refund...EVEN IF YOU BOUGHT IT RETAIL! (Hardware ordered direct must be returned within 10 days.)

THE ONLY CATCH: You gotta tell us why you don't like it. Otherwise we'll never get better. Send the product back to us and we promise we'll make things right. (If you bought it at a retail outlet, please send original sale receipt.)

DISK REPLACEMENT NOTICE

The publisher of this software wants your continued business. If your software should fail within 90 days of purchase, return it directly to us, and we will replace it free. After 90 days, enclose \$10 and return the software directly to us. This warranty gives you specific legal rights, and you may also have other rights which vary from state to state.

Replacement Diskettes/CDs

Should you receive faulty or damaged disks/CDs, send the original disk #1 to:

U.S.

Sierra On-Line
Fulfillment
P.O. Box 485
Coarsegold, CA 93614
Attention: RETURNS

EUROPE (U.K.)

Sierra On-Line Limited
Attention: Returns
4 Brewery Court
The Old Brewery
Theale, Reading, Berkshire
RG7 SAJ, United Kingdom

Include a note stating your game machine type and the size of diskette you need (3.5" or 5.25" or CD). We will gladly replace your program free of charge for the first 90 days of ownership. (Please enclose a copy of your dated sales receipt with your request.) After 90 days there is a \$10.00 (£6.00) charge. This policy applies to the original purchaser only.



Dynamix[®]
PART OF THE SIERRA FAMILY



© and ™ indicate trademarks of, or licensed to, Dynamix, Inc.
©1994 Dynamix, Inc. All rights reserved. Printed in the U.S.A.

3DO, the 3DO logos and Interactive Multiplayer are
trademarks of The 3DO Company.

036351000