



Bandai  
Digital  
Entertainment

Pippin™ @WORLD®

# User's Manual

.....



.....

# Contents

Communications regulation information .....	vi
Laser information .....	vii
Warning Labels .....	viii
<b>1 Setting Up Your @World .....</b>	<b>1</b>
Component list .....	2
Safety first .....	3
Care and handling .....	5
Special setups .....	6
Choosing a good location for your @World .....	6
Connecting the @World to your television .....	7
Connecting the stereo audio/composite video cable .....	7
Connecting the audio cables to your home stereo or stereo VCR .....	9
Selecting the appropriate video mode .....	10
Attaching the power cord .....	10
Attaching the hand-held controller .....	12
Turning on the equipment .....	12

<b>2</b>	<b>Playing Pippin CDs</b>	<b>.15</b>
	Inserting a Pippin CD	.15
	Using the @World controller	.17
	Directional pad	.17
	Trackball	.17
	Left and right trigger buttons	.17
	Primary action buttons	.18
	Secondary action buttons	.18
<b>3</b>	<b>Playing Audio CDs</b>	<b>.19</b>
	Inserting an audio CD	.19
	Using the basic audio CD controls	.21
	Power	.21
	Start/Pause	.21
	Stop	.21
	Volume Down and Volume Up (headphones)	.22
	Skip Back/Skip Forward	.22
	Open/Close (CD tray)	.22
	Using the on screen audio CD controls	.23
<b>4</b>	<b>Tips and Troubleshooting</b>	<b>.25</b>
	Care and cleaning	.25
	Cleaning the @World	.25
	Cleaning the @World controller	.26
	Troubleshooting	.27

<b>Appendix A</b>	<b>Adding Memory and Connecting Other Devices</b> . . . . .	<b>31</b>
	Adding additional memory to your @World . . . . .	31
	Your @World Keyboard. . . . .	33
	Attaching a stacking expansion unit . . . . .	33
	Connecting the @World to your VGA monitor . . . . .	35
	Selecting the appropriate video mode . . . . .	36
	Connecting the @World to your VCR . . . . .	37
	Routing sound to the @World . . . . .	39
	Connecting a modem and printer . . . . .	40
	Connecting and use of an RF modulator . . . . .	41
<b>Appendix B</b>	<b>Technical Information</b> . . . . .	<b>43</b>

<b>2</b>	<b>Playing Pippin CDs</b>	<b>.15</b>
	Inserting a Pippin CD	.15
	Using the @World controller	.17
	Directional pad	.17
	Trackball	.17
	Left and right trigger buttons	.17
	Primary action buttons	.18
	Secondary action buttons	.18
<b>3</b>	<b>Playing Audio CDs</b>	<b>.19</b>
	Inserting an audio CD	.19
	Using the basic audio CD controls	.21
	Power	.21
	Start/Pause	.21
	Stop	.21
	Volume Down and Volume Up (headphones)	.22
	Skip Back/Skip Forward	.22
	Open/Close (CD tray)	.22
	Using the on screen audio CD controls	.23
<b>4</b>	<b>Tips and Troubleshooting</b>	<b>.25</b>
	Care and cleaning	.25
	Cleaning the @World	.25
	Cleaning the @World controller	.26
	Troubleshooting	.27

<b>Appendix A</b>	<b>Adding Memory and Connecting Other Devices . . . . .</b>	<b>31</b>
	Adding additional memory to your @World . . . . .	31
	Your @World Keyboard. . . . .	33
	Attaching a stacking expansion unit . . . . .	33
	Connecting the @World to your VGA monitor . . . . .	35
	Selecting the appropriate video mode . . . . .	36
	Connecting the @World to your VCR . . . . .	37
	Routing sound to the @World . . . . .	39
	Connecting a modem and printer . . . . .	40
	Connecting and use of an RF modulator . . . . .	41
<b>Appendix B</b>	<b>Technical Information . . . . .</b>	<b>43</b>

## Communications regulation information

### FCC statement

This equipment has been tested and found to comply with the limits for a Class B digital device in accordance with the specifications in Part 15 of FCC rules. See instructions if interference to radio or television reception is suspected.

### Radio and television interference

The equipment described in this manual generates, uses, and can radiate radio-frequency energy. If it is not installed and used properly—that is, in strict accordance with Bandai Digital Entertainment's instructions—it may cause interference with radio and television reception.

This equipment has been tested and found to comply with the limits for a Class B digital device in accordance with the specifications in Part 15 of FCC rules. These specifications are designed to provide reasonable protection against such interference in a residential installation. However, there is no guarantee that interference will not occur in a particular installation.

You can determine whether this equipment is causing interference by turning it off. If the interference stops, it was probably caused by the equipment or one of the peripheral devices.

If your equipment system does cause interference to radio or television reception, try to correct the interference by using one or more of the following measures:

- Turn the television or radio antenna until the interference stops.
- Move the equipment to one side or the other of the television or radio.
- Move the equipment farther away from the television or radio.
- Plug the equipment into an outlet that is on a different circuit from the television or radio.  
(That is, make certain the equipment and the television or radio are on circuits controlled by different circuit breakers or fuses.)

You may find the following booklet helpful: *Interference Handbook* (stock number 004-000-00493-1). This booklet, prepared by the Federal Communications Commission, is available from the U.S. Government Printing Office, Washington, DC 20402.

**IMPORTANT** Changes or modifications to this product not authorized by Bandai Digital Entertainment Corporation, could void the FCC Certification and negate your authority to operate the product.

This product was tested for FCC compliance under conditions that included the use of Bandai Digital Entertainment Corporation peripheral devices and Bandai Digital Entertainment shielded cables and connectors between system components. It is important that you use Bandai Digital Entertainment peripheral devices and shielded cables and connectors between system components to reduce the possibility of causing interference to radios, television sets, and other electronic devices. You can obtain Bandai Digital Entertainment peripheral devices and the proper shielded cables and connectors through Bandai Digital Entertainment.

### Status light

- Green (steady): the @World is on and in use
- Green (flashing): the @World is not working correctly

### Temperature

#### Celsius (C) and Fahrenheit (F)

- Operating temperature 5° C–40° C (41° F–104° F)
- Storage temperature -40° C–65° C (-40° F–149° F)

### Humidity

- Operating 8% to 90% noncondensing
- Storage 5% to 95% noncondensing

### Power requirements

- 100–240 V
- 50/60 Hz
- max. 0.5 Amp



# 1

## Setting Up Your Pippin™ @World®

Congratulations on your purchase of the Pippin @World (sometimes just referred to as the “@World”). After opening your @World, you should have the following items if you purchased the Model PW-20000 (Model PW-20010 does not include the @World keyboard).

This chapter introduces the Pippin @World and explains how to set it up.

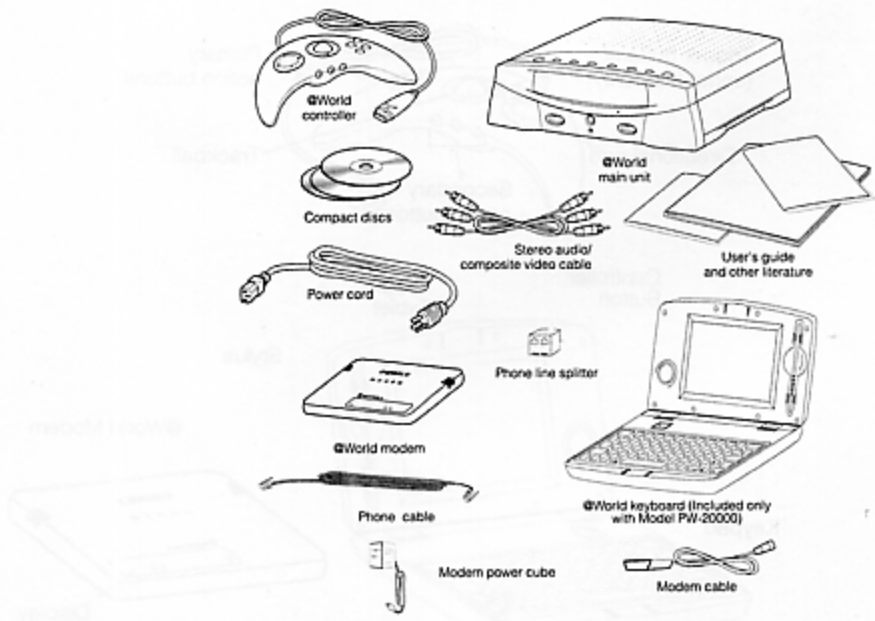

## Front

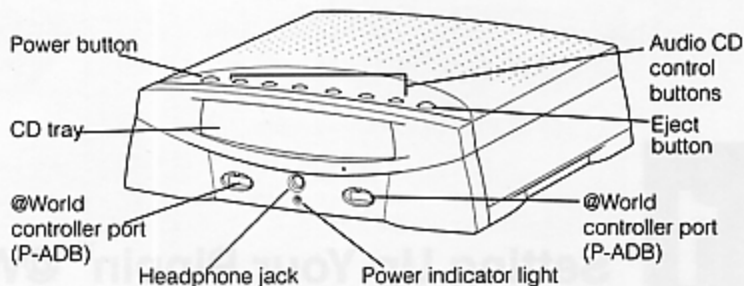

## Back

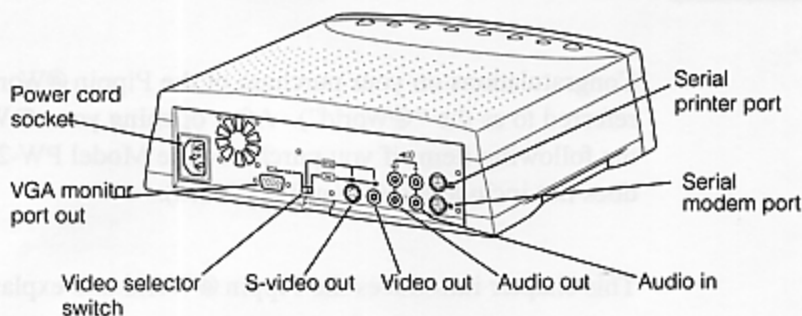

## Controller

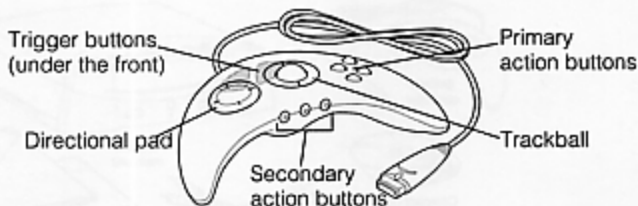

## Keyboard and Modem

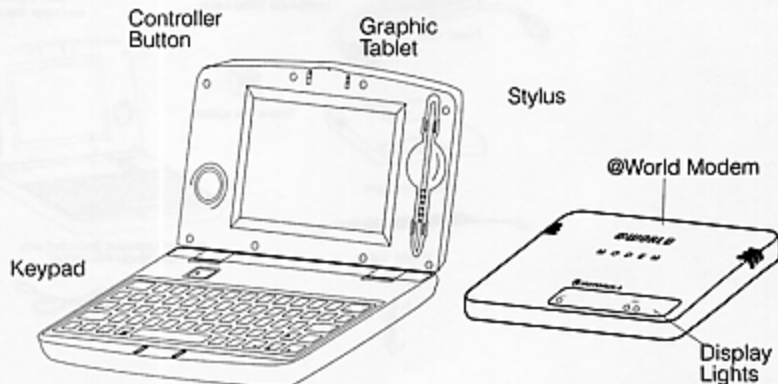

## Safety first

Before you continue, please read these important safety instructions.

For your own safety and that of your equipment, always take the following precautions.

Disconnect the power plug (by pulling the plug, not the cord) if any of the following conditions exists:

- the power cord or plug becomes frayed or otherwise damaged
- you spill something into the case
- your @World is exposed to rain or any other excess moisture
- your @World has been dropped or the case has been otherwise damaged
- you suspect that the @World needs service or repair
- you want to clean the case (use only the cleaning instructions given in Chapter 4)

Be sure that you always do the following:

- Keep your @World away from sources of liquids, such as wash basins, bathtubs, shower stalls...etc.
- Protect your @World from dampness or wet weather, such as rain, snow, and so on.
- Keep these instructions handy for reference by you and others.
- Follow all instructions and warnings concerning your system.

**WARNING** Electrical equipment may be hazardous if misused. Operation of this product, or similar products, must always be supervised by an adult. Do not allow children access to the interior of any electrical product and do not permit them to handle any cables.

- Do not leave the disc tray open. If dust gets on the lens of the @World, the unit may have problems reading your CDs.
- Do not put anything (for instance, a cup) on top of the tray when it is open.
- Do not force the tray open by hand.
- Do not transport your @World while a disc is inside the unit.

**WARNING** Do not let children under the age of four use the @World controller without adult supervision. The hand-held controller contains small objects that, if removed from the controller, can pose a choking threat if swallowed.

**WARNING** Still pictures or images may cause permanent picture-tube damage or mark the phosphor of the picture tube. Avoid repeated or extended use of CDs on large-screen projection televisions. Consult your TV user's manual before playing a CD on your projection television.

**WARNING** Like any activity that involves prolonged periods of sitting, using the @World can make you tired and stiff. In addition, using a keyboard improperly can sometimes be associated with RSIs (repetitive stress injuries), particularly in the wrist. If at any time during or after typing you feel discomfort, including aching, numbness or tingling in one or both hands, wrist, elbows, shoulders or neck/back you should consult a physician.

To lesson the chance of injury/discomfort, we suggest:

- Take frequent breaks from typing.
- Make sure to keep your wrist straight.
- Avoid using unnecessary force when typing.

## Care and handling

Keep these important safety instructions in mind as you use compact discs (CD's):

- Hold a disc by the edges or by one edge and the center hole. Do not touch the disc surface.
- To clean discs, wipe the shiny (non-labeled) surface with a soft, damp cloth, working in straight lines from center to edge. Do not use any form of cleaning agent.
- To avoid damage to your discs, follow these guidelines:



Do not expose discs to direct sunlight or excessive heat.



Do not write on discs.



Do not spill liquids on discs.



Do not put tape on discs.



Do not scratch discs.



Do not get dust on discs.

## Special setups

When setting up your @World, there are two special situations you might want to take note of:

- **You may want to use a VGA computer monitor instead of your TV.** As an alternative to connecting the @World to your TV, you can connect it to your VGA monitor. For more information, see Appendix A. When you are done, return to this chapter for information on how to attach the @World controller and how to turn on the equipment.
- **Your TV doesn't have a video input jack.** If your TV doesn't have a video input jack, you cannot connect the @World directly to your TV. Instead, you can connect the @World to your videocassette recorder (VCR) or to your TV through an RF modulator. We recommend a Radio Shack RF modulator, catalog number 15-1283. For more information, see Appendix A. When you're done, return to this chapter for information on how to attach the @World controller and how to turn on the equipment.

## Choosing a good location for your @World

You need to put your @World in a place where it can have plenty of ventilation.

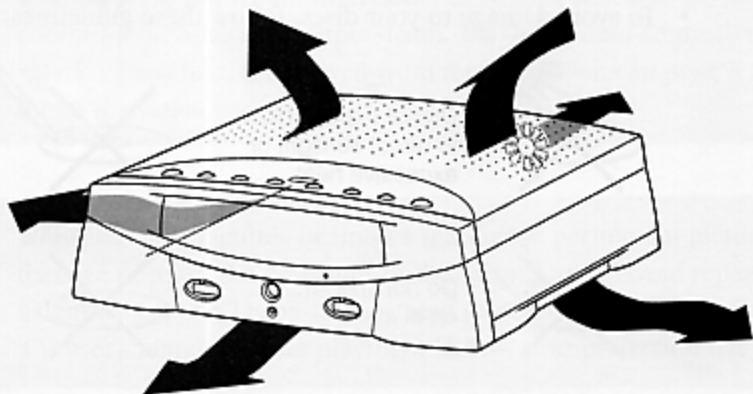

## Connecting the @World

It is important that you:

- don't put the @World on top of anything that generates heat, such as an audio amplifier.
- don't place the @World on a soft carpet, bed, sofa or similar surface.
- don't push the @World up against the wall or similar hard vertical surface.
- don't push sharp objects into any of the @World openings, this could cause shorts and pose a hazard.
- don't attempt to service the @World yourself, you will void your warranty and could be exposed to lethal voltages

It is a good idea to place the unit on a stable hard surface, such as a table, next to your TV.

## Connecting the @World to your television

To connect the @World to your TV, use the stereo audio/composite video cable and power cord that came in the box.

**WARNING** Before you connect the @World to your TV, make sure that they are both turned off.

## Connecting the stereo audio/composite video cable

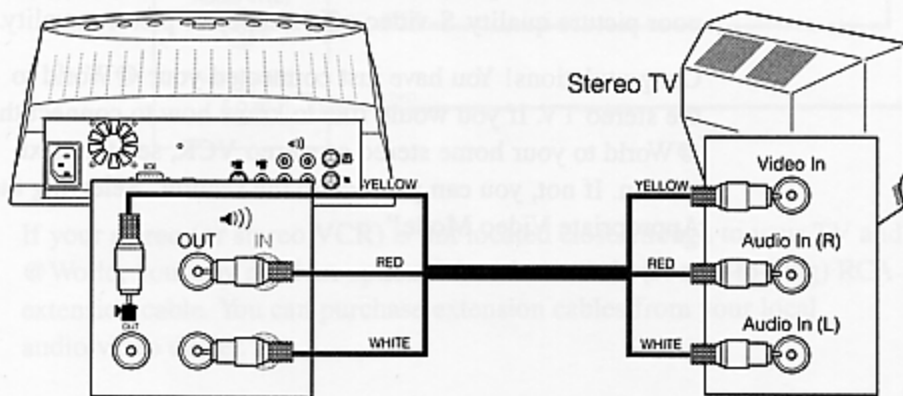

**IMPORTANT** If your TV doesn't have a video input jack, you can connect the @World to your VCR's video input jack or use an RF modulator (See Appendix A for more information).

**IMPORTANT** If your TV doesn't have two audio input jacks, and you would like to hear stereo see Appendix A for how to connect the audio cables to your home stereo or stereo VCR.

- 1** Insert the yellow plug of the stereo audio/composite video cable into the video jack on the back of the @World.
- 2** Insert the other yellow plug into your TV's video input jack.
- 3** Insert one of the red plugs into the right audio output jack, and one of the white plugs into the left audio output jack of the @World.
- 4** Insert the other red plug into the right audio input jack, and the other white plug into the left audio input jack of your TV.

Note that if your TV supports super-video (S-video), you can use an S-video cable (not included) instead of the composite video cable portion (yellow plugs) of the stereo audio/composite video cable. An S-video cable may be obtained at your local consumer electronics retailer. If you use an S-video cable, do not use the yellow plugs of the stereo audio/composite video cable. If you do, you'll have poor picture quality. S-video offers superior picture quality.

Congratulations! You have just connected your @World to the stereo TV. If you would like to know how to connect the @World to your home stereo or stereo VCR, see the next section. If not, you can proceed to the section "Selecting the Appropriate Video Mode."



## Connecting the audio cables to your home stereo or stereo VCR

If your TV has only one audio input jack, you can connect the audio cables to your home stereo or stereo VCR, as shown here.

**IMPORTANT** If you do not have a home stereo or stereo VCR, you can use a stereo-to-mono audio adapter to connect the audio cables to your @World. You can obtain a stereo-to-mono audio adapter from your local audio/video dealer.

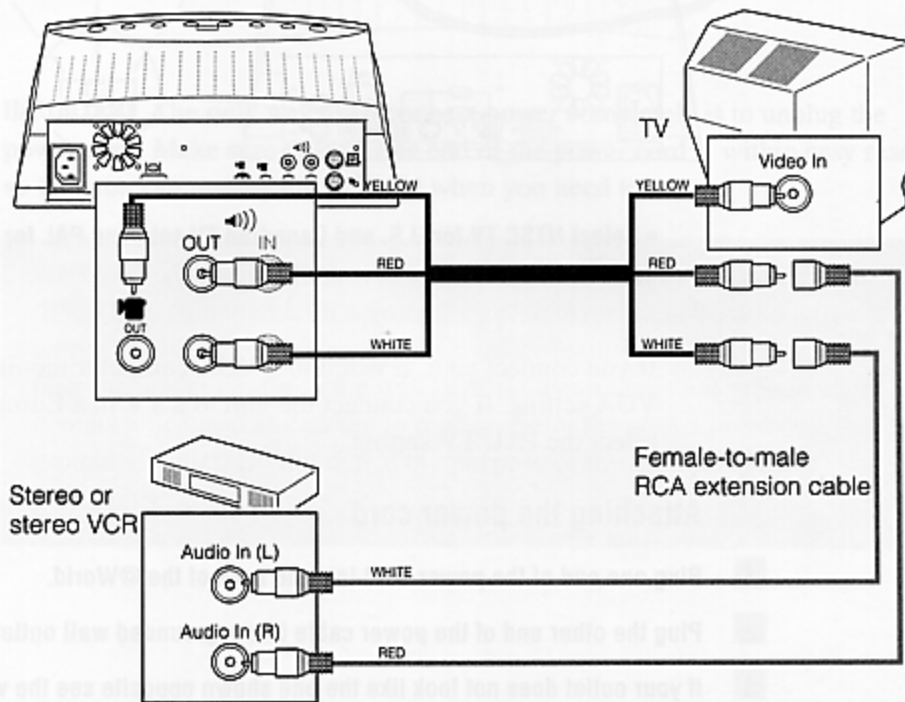

If your stereo (or stereo VCR) is not located close enough to your TV and @World, you may need an optional female-to-male (socket-to-plug) RCA extension cable. You can purchase extension cables from your local audio/video dealer.

## Selecting the appropriate video mode

Your @World supports three different video monitors: VGA computer monitors, NTSC TV, and PAL TV. Place the switch to the type of monitor that you are using. For information on how to use your @World with a VGA monitor, see Appendix A. Switch video modes only while power is off. If switched while on, your @World must be powered off then on again before the video mode change can take effect.

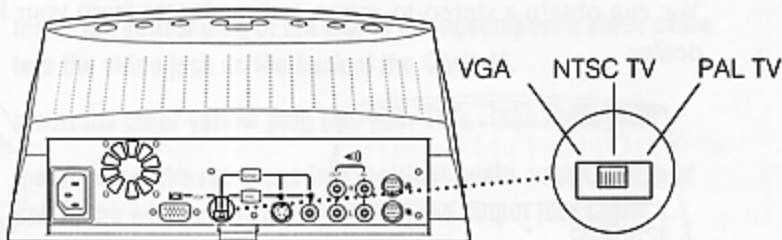

- Select NTSC TV for U.S. and Canadian TV sets and PAL for European TV sets.

If you connect your @World to a VGA computer monitor, select the VGA setting. If you connect the unit to a TV in a European country, select the PAL TV setting.

## Attaching the power cord

- 1 Plug one end of the power cord into the back of the @World.
- 2 Plug the other end of the power cable into a grounded wall outlet.
- 3 If your outlet does not look like the one shown opposite see the warning on the next page.

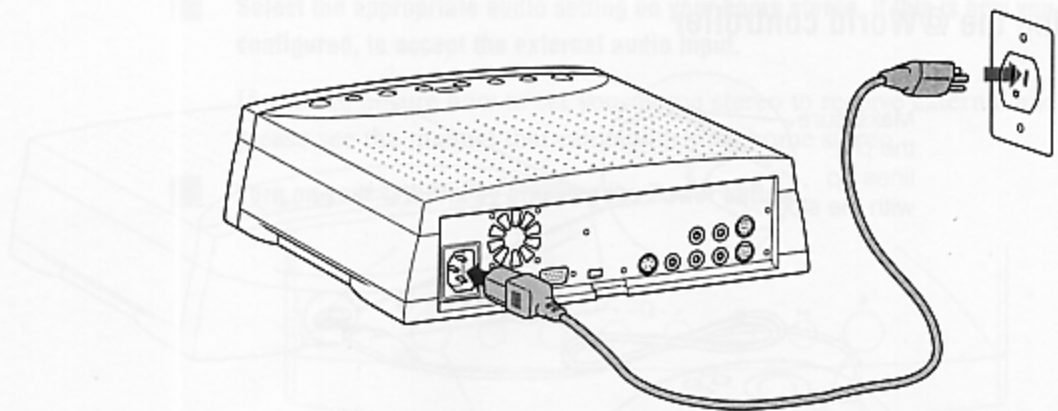

**IMPORTANT** The only way to disconnect power completely is to unplug the power cord. Make sure at least one end of the power cord is within easy reach so that you can unplug the @World when you need to.

**WARNING** This equipment is intended to be electrically grounded. Your @World is equipped with a grounding plug that should be used only with a grounded AC outlet. This is a safety feature. If you are unable to plug the power cord into the wall because the outlet is not grounded, contact a licensed electrician to replace the outlet with a properly grounded outlet. Do not defeat the purpose of the grounding three prong plug.

## Attaching the @World controller

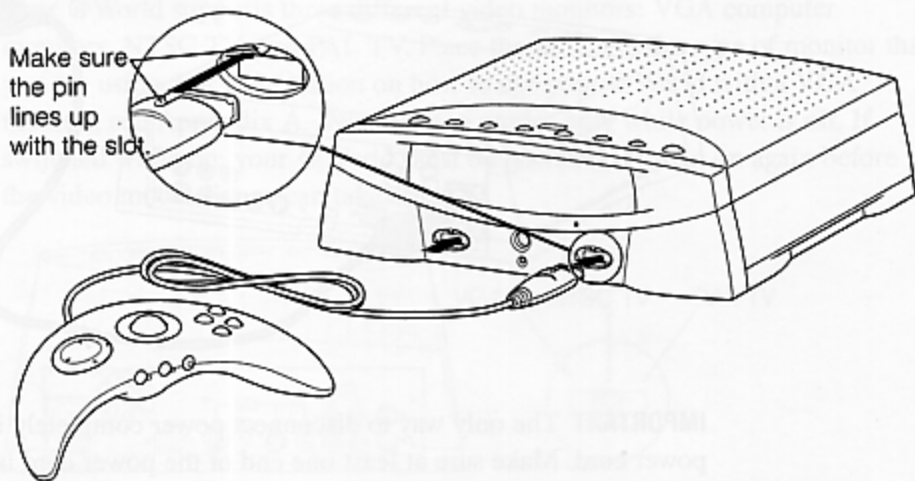

To connect the @World controller:

- **Plug the @World controller's cable into one of the two controller ports on the front of the @World.**

*By the way:* You can also connect other selective @World input devices—like keyboards and joysticks—to these ports.

## Turning on the equipment

Once you have connected the @World to your TV and attached the @World controller, you are ready to turn on the equipment.

- 1 Turn on your TV (and home stereo and VCR, if they are connected), leave your @World off at this point.**
- 2 Select the appropriate video setting on your TV to accept the external video input.**

If you are unsure how to set your TV to receive external video input, please see the manual that came with your TV.

If you connected the @World unit to your VCR (and not directly to your TV), select the TV channel you normally use with your VCR.

- 3** Select the appropriate audio setting on your home stereo, if this is how you are configured, to accept the external audio input.

If you are unsure how to set your home stereo to receive external audio input, please see the manual that came with your home stereo.

- 4** Turn on your @World by pressing the Power button.

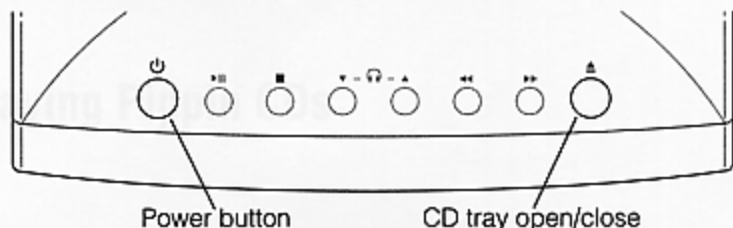

The Power button is at the top left of the @World. Hold down the button for about one second then release. When the @World is turned on, you will see a green light on the front of the unit.

See the next two chapters to find out how to play Pippin CDs and audio CDs on your @World.

## Inserting a Pippin CD

To get ready to play a Pippin CD, follow these steps:

- 1** Make sure that the @World and your TV are turned on.

If you connected your home stereo, VCR, or other components to your @World, make sure that they are turned on.

- 2** Press the Open/Close button to open the CD tray.

The Open/Close button is at the top of the @World on the far right-hand side.

## 2

## Playing Pippin CDs

Your @World and @World Controller enable you to play Pippin CDs. A Pippin CD is a CD that is specifically designed to play on your @World (the content of a Pippin CD is called a Pippin title). A wide selection of Pippin CDs are available for entertainment, education, and business. You can recognize a Pippin CD by its Pippin logo.

This chapter describes how to insert a Pippin CD into the @World and how to use the @World controller.

### Inserting a Pippin CD

To get ready to play a Pippin CD, follow these steps:

- 1 Make sure that the @World and your TV are turned on.**

If you connected your home stereo, VCR, or other components to your @World, make sure that they are turned on.

- 2 Press the Open/Close button to open the CD tray.**

The Open/Close button is at the top of the @World on the far right-hand side.

- 3** Place the Pippin CD in the tray, with the disc label facing up.

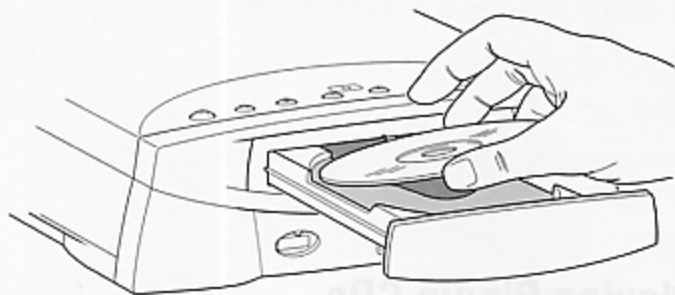

Make sure the Pippin CD is lying flat in the tray.

- 4** Gently push the tray in, or press the Open/Close button, to close the tray.

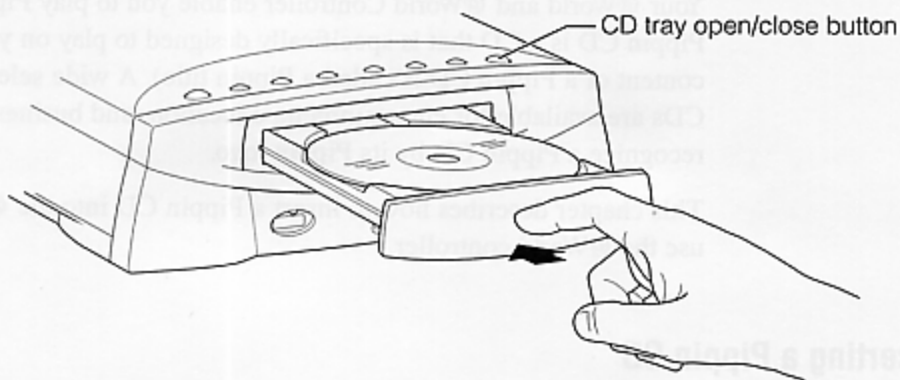

In a few moments, the first image of the Pippin title appears on your TV. For instructions on how to play the title, please refer to the manual that came with the Pippin CD.

The next section describes how to use the @World controller to play and navigate through a Pippin CD.

## Using the @World controller

The @World controller is the small, cable-connected control unit you use to play your Pippin titles. On it, you'll find navigation, trigger, and action buttons.

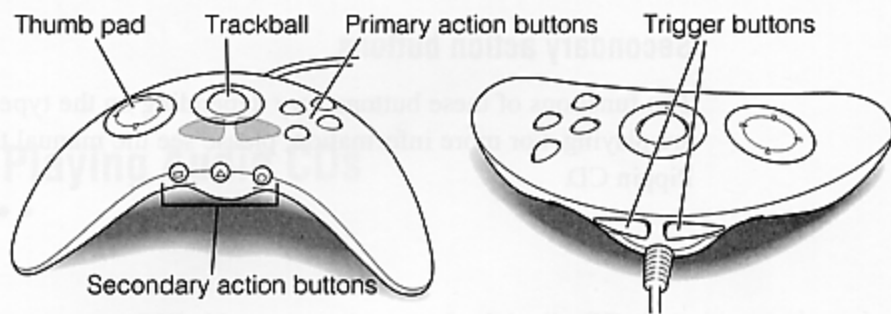

The function of each button is determined by the Pippin title you're playing. In many cases, however, you'll find that the buttons behave similarly from title to title.

### Thumb pad

Use the thumb pad to navigate and position your game character (or other object that you are controlling) to the right, left, up, or down.

### Trackball

Use the trackball to navigate and position your game character (or other object that you are controlling) anywhere on the screen. You can use the trackball to move in any direction quickly and easily.

### Left and right trigger buttons

Use these buttons to trigger or select an action. The action that you trigger (or select) depends on the type of Pippin title you are playing. For example, for warrior-type games the action may be a jump, kick, or punch.



## Primary action buttons

The functions of these buttons vary depending on the type of game you are playing. For more information, please see the manual that came with your Pippin CD.

## Secondary action buttons

The functions of these buttons vary depending on the type of Pippin title you are playing. For more information, please see the manual that came with your Pippin CD.

## Using the basic Audio CD controls

When you place an Audio CD in the @World, it works like a typical Audio CD player. If you use your TV as your audio source, you must have your TV on to hear sound from the @World.

You use the Audio CD controls, located on top of your @World, to play the Audio CD. The Audio CD controls include the six buttons located in the middle. The Power and Open/Close buttons are used for all types of CDs.

# 3

## Playing Audio CDs

With your @World you can play standard Audio CDs found in music and record stores.

This chapter describes how to insert an Audio CD and how to play it using the basic Audio CD controls.

### Inserting an Audio CD

To get ready to play an Audio CD, follow these steps:

- 1 Make sure that the @World is turned on.**

If you connected your home stereo, VCR, or other components to your @World, make sure that they are turned on.

- 2 Press the Open/Close button to open the CD tray.**

The Open/Close button is at the top of the @World, on the far right-hand side.

button to start the Audio CD. When the Audio CD is playing, you can press it by pressing this button again.

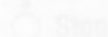

Stops play and resets the track to number 1.

- 3** Place the Audio CD in the tray, with the disc label facing up.

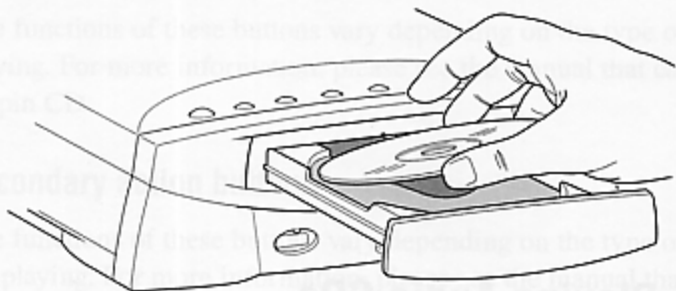

Make sure the Audio CD is lying flat in the tray.

- 4** Gently push the tray in, or press the Open/Close button, to close the tray.

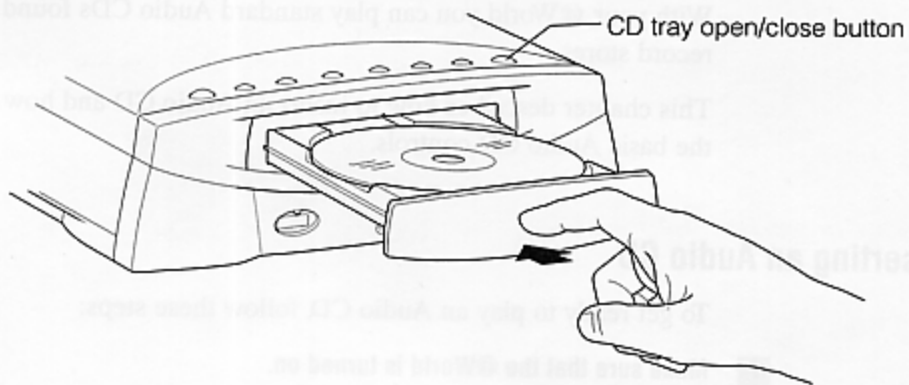

Once the Audio CD is inserted, you are ready to use the Audio CD controls—located on top of your @World—to play the Audio CD.

## Using the basic Audio CD controls

When you place an Audio CD in the @World, it works like a typical Audio CD player. If you use your TV as your audio source, you must have your TV on to hear music from the @World.

You use the Audio CD controls, located on top of your @World, to play the audio CD. The Audio CD controls buttons are the six buttons located in the middle. The Power and Open/Close buttons are used for all types of CDs.

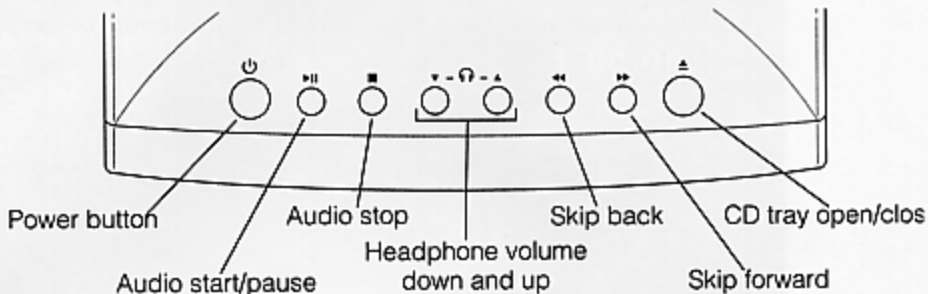

### Power

Turns your @World on and off. Press and hold the button for about a second then release. When the unit is on, you will see a green indicator light on the front panel.

**IMPORTANT** The only way to disconnect power completely is to unplug the power cord.

### Start/Pause



Starts or pauses the Audio CD. When you first insert an audio CD, press this button to start the Audio CD. When the Audio CD is playing, you can pause it by pressing this button again.

### Stop

Stops play and resets the track to number 1.

  **Volume Down and Volume Up (headphones)**

You can use these buttons to adjust the volume for the headphones attached to the @World. Press the Volume Down button to decrease the volume and the Volume Up button to increase the volume.

  **Skip Back/Skip Forward**

You can use these buttons to move to the beginning of the previous track or next track.

 **Open/Close (CD tray)**

Opens and closes the CD tray.

## Using the on Screen Audio CD Controls

Alternately, you can use your TV and @World controller to control the audio CD function of your @World. At the "Insert CD" screen of your @World, just insert an Audio CD and the following screen display will appear.

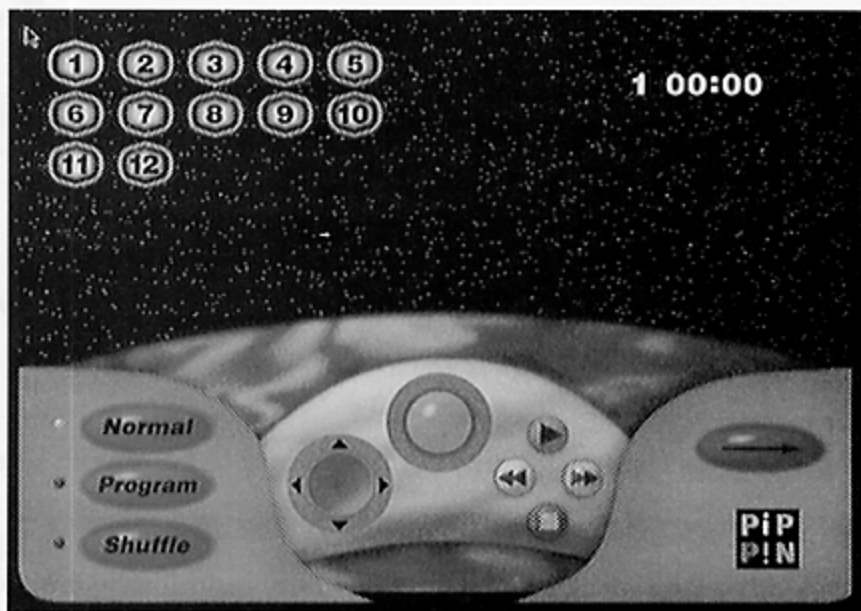

### The definition and use of each button follows:



#### Number Buttons

These number icons represent the songs, or tracks, on your Audio CDs. Click any one to play that track. These icons are also used to program what order the tracks will play. (See Program button).



#### Normal

Normal plays the CD from beginning to end.



### Program

Program allows you to specify which song plays first. To program the order of your songs do the following:

- 1** Click on the "Program" button.
- 2** Click on the Number Icons in the order you wish them to play. The order will appear on the upper right side of your screen as you make your selections.
- 3** To play your selections you can either click on the play icon, or press the blue button on your @World controller.



### Shuffle

Shuffle plays the songs on the Audio CD in random order.



### Thumb pad

The Thumb Pad lets you move through the Number Icons in the directions of the arrows.



### Play

Plays and pauses the Audio CD. (Blue button on the @World controller).



### Fast forward

Plays the Audio CD in fast forward. (Green button on the @World controller).



### Rewind

Plays the Audio CD in reverse. (Yellow button on the @World controller).



### Stop

Stops the Audio CD from playing. (Red button on the @World controller).



### Loop

This button allows you toggle between playing the Audio CD once through or playing it in a loop continuously.

# 4

## Tips and Troubleshooting



This chapter includes information on how to care for your @World and @World controller. It also describes solutions to problems you may encounter while using them.

If the suggestions in this chapter don't solve your problem, refer to the service and support information that came with your @World. It describes where you can obtain technical assistance.

### Care and cleaning

Follow these general rules when cleaning the outside of your @World and @World controller:

- Use a damp, soft, lint-free cloth to clean the @World's and @World controller's exteriors. Avoid getting moisture in any openings.
- Don't use aerosol sprays, solvents, or abrasives.

### Cleaning the @World

**WARNING** Be sure to keep the vents of the @World free from obstructions.



To clean the case of the @World, do the following:

- 1 Turn your TV and @World off.
- 2 Disconnect the power plug of the @World from the grounded AC outlet.
- 3 Wipe the surfaces of the @World lightly with a clean, soft cloth dampened with water.

## Cleaning the @World controller

To clean the case of the @World controller:

- 1 Disconnect the @World controller from your @World.
- 2 Wipe the surfaces of the @World controller lightly with a clean, soft cloth dampened with water.

To clean the trackball in the @World controller, do the following:

**WARNING** The cleaning of the @World controller trackball must be supervised by an adult. The trackball, when removed from the controller, poses a choking threat to young children.

- 1 Insert a straightened paper clip into one of the holes on the plastic ring. Turn the ring counterclockwise.

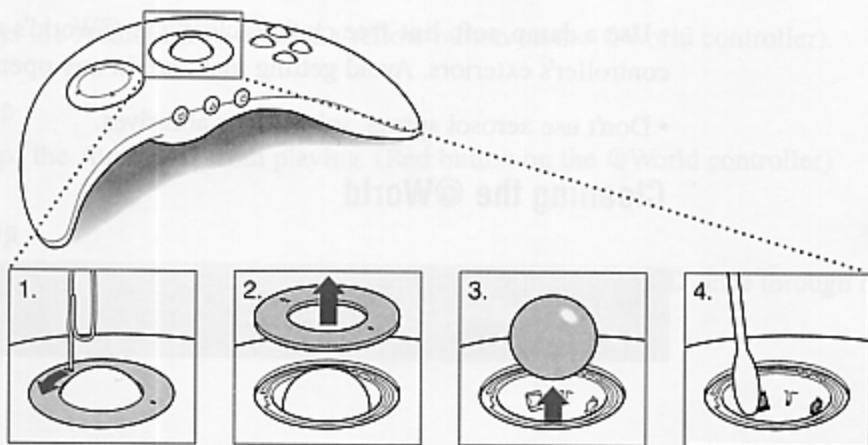

- 2** Turn the @World controller upside down with one hand and catch the ring and the ball with your other hand.
- 3** Clean the small rollers inside the trackball area with a cotton swab moistened with water.  
Rotate the rollers to clean all around them.
- 4** Wipe the trackball with a clean, soft, dry, and lint-free cloth.  
  
If necessary, wash the trackball with warm soapy water (use a mild soap such as a dishwashing liquid) and then dry the trackball thoroughly.
- 5** Put the ball and ring back in place.
- 6** Insert a straightened paper clip into the hole on the plastic ring.
- 7** Turn the ring clockwise until the triangle on the ring aligns with the triangle outside the ring.

The trackball is now locked back into place and should roll smoothly. If it doesn't, repeat these instructions.

## Troubleshooting

**WARNING** If you have a problem with your @World and nothing presented in this manual solves it, consult the service and support information that came with your unit for instructions on how to contact an authorized service provider for assistance. If you attempt to repair the @World yourself, any damage you may cause to the unit will not be covered by the limited warranty on your @World. Contact an authorized dealer or service provider for additional information about this or any other warranty question.

Solutions to common problems related to your @World are described here. Problems related to the TV are covered in the manuals that came with your TV.

**WARNING** To reduce the risk of electric shock, do not remove the cover. No parts inside the unit can be serviced by the user. If you have a problem, please contact your authorized service provider.

**The @World's indicator light doesn't come on.**

- Make sure that the power cord is plugged in properly.  
*If the unit's power cord is plugged in to a wall outlet, make sure that the cord is firmly plugged in. Check to see whether power to the outlet has been interrupted. You can test the outlet by plugging in something that you know works, such as a desk lamp or radio. If the test appliance works, but the @World doesn't, contact an authorized dealer or service provider.*

**There's no image on the TV screen and the @World's power indicator light is on.**

- Make sure the TV's power cord is plugged in properly.  
*If the TV's power cord is plugged into a wall outlet, make sure the cord is firmly plugged in. Check to see whether power to the outlet has been interrupted.*
- Make sure the TV is turned on, and that it is set to accept the appropriate external video input.
- Make sure the video cable is properly attached.
- Make sure that only one video cable is attached (you can attach a stereo audio/composite video cable or S-video cable, but not both at the same time).
- Make sure that you selected the appropriate video monitor setting (VGA, NTSC, or PAL).

**There's no sound when you play an audio CD.**

- Make sure the stereo's power cord is plugged in properly.  
*If the stereo's power cord is plugged into a wall outlet, make sure the cord is firmly plugged in. Check to see whether power to the outlet has been interrupted.*
- Make sure the stereo is turned on, and that it is set to accept the appropriate external audio input.

- If you are using headphones, make sure that they are plugged in properly.
- Make sure the CD is playing. Press the Play/Pause button.

#### **The tray of your @World won't open.**

- Press the Open/Close button of your @World.
- Turn off your @World with the Power button, wait at least 10 seconds, and then turn it on again. If that doesn't work, turn off your @World. Locate the small pinhole right below the CD tray opening. Insert the end of a large straightened paper clip horizontally into the pinhole. Push gently but firmly until the tray is released, then carefully pull the tray open. Do not force the tray open; wait until the paper clip has dislodged it slightly, or you may break the front of the tray.

#### **You inserted a CD, but it doesn't show up on the TV screen.**

- Make sure that it's a Pippin CD or audio CD.
- Make sure the disk label is facing up and the disc is centered in the tray.

**WARNING** Turn off your @World before you attempt to open the tray using a paper clip. If you don't, the @World may malfunction.

- Make sure the tray is closed all the way.
- Try restarting your @World.

#### **The @World ejects the CD you're trying to insert.**

- Make sure the disk is flat and centered in the tray and the disk label is facing up.
- The disk may need to be cleaned. See "Care and Handling" in Chapter 1. If there are no visible scratches on the shiny side of the disk, you may be able to remove them with a CD polishing kit (available from your audio CD dealer). If the scratches can't be removed, you'll need to replace the disk.
- The disk may be damaged. Try another disk in your @World, or try the problematic disk in another CD unit. If the original CD unit reads other discs, or if the problematic disc doesn't work in another unit, the disc is probably damaged. You'll need to replace the disc.

**The @World's clock keeps time inaccurately.**

- Your @World has a clock that runs continuously. When the @World is turned off, the battery keeps the clock running. If your clock begins to keep time inaccurately, have an authorized service provider replace the battery. Consult the service and support information that came with your @World for instructions on how to contact an authorized service provider. To get more life out of the battery, keep your @World plugged in.

**The @World controller's trackball doesn't work.**

- If the trackball doesn't work with one of your Pippin CD's, but works with other CDs, check the manual that came with the CD. Not all Pippin titles utilize the trackball.
- If the trackball only works in one direction (up-down or left-right), you may need to clean it. (See the section "Care and Cleaning" in this chapter.)
- If the trackball doesn't work at all, contact an authorized dealer or service provider for additional information.

**While using the modem to get on the internet or send & receive E-mail, it unexpectedly hangs up and you lose your connection.**

- Check to make sure that the cables and power supply to your modem are connected securely.
- If your cables and modem are connected properly then you have received an incoming phone call on the call waiting feature on the same phone line you are using with your @World Modem.
- To disable Call Waiting check with your local phone company for the code, run the Setup CD and enter the Call Waiting disable code in the appropriate set up field.
- Your Call Waiting option will only be disabled while you are using your @World and its Modem to view the internet. Your phone line will return to normal when you are through.



## Appendix A

# Adding Memory and Connecting Other Devices

If you wish to:

- add additional memory to your @World
- connect your @World keyboard
- attach a stacking expansion unit to your @World
- connect your @World to your VCR
- connect your @World to a VGA computer monitor
- route audio to your @World

—follow the instructions in this appendix.

This appendix also illustrates where you can connect additional equipment—like a printer and modem—to your @World.

### **Adding additional memory to your @World**

You can expand your @World's memory by adding a memory expansion module (X-Mem). The memory expansion module is available in three different configurations of random-access memory (RAM), 2 MB, 4 MB, and 8 MB.

The @World has 6 MB, with 4 MB used for playing the titles and music tracks on the CDs. Some Pippin titles may require more than 4 MB to run; if they do, you can add additional memory to your @World. (The memory requirement of each CD is listed on its cover.)

To add a memory expansion module to your @World, do the following:

**WARNING** Turn off and disconnect the @World from all cables, before you add memory. If you don't, the @World and/or the memory may malfunction.

- 1 Tilt the @World so that the bottom is exposed.**

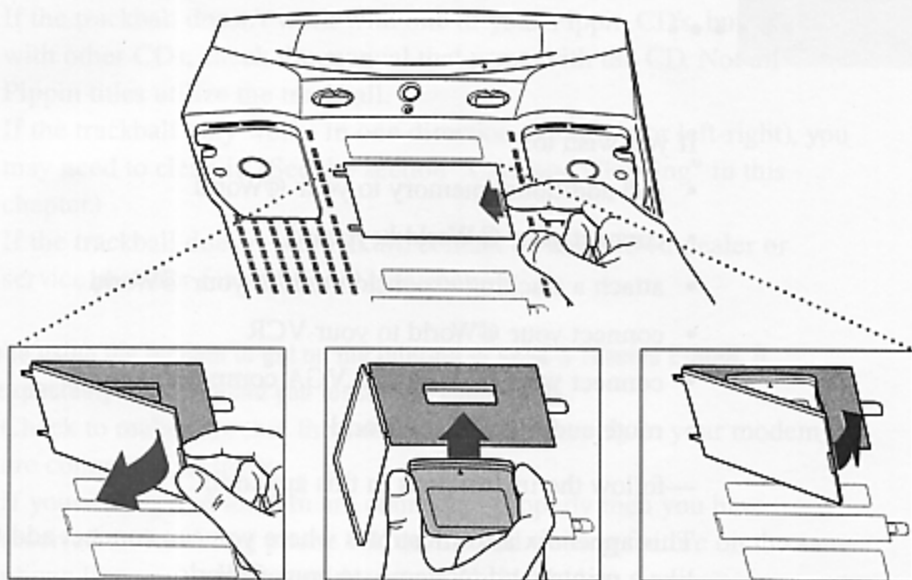

- 2 Depress the latch, then gently swing the panel open.**
- 3 Align the memory expansion module over the memory connector and press the module into place on the connector.**
- 4 Swing the panel back up and snap it into place.**

**WARNING** Never turn on your @World unless all of its internal and external parts are in place. Operating the @World when it is open or missing parts can be dangerous, and can damage your @World.

## Your @World keyboard (Optional with model PW-20010)

Your @World keyboard allows you to enter text on a computer style keyboard. It also includes a built in graphics tablet for sketching and drawing programs. You can attach the keyboard to your @World as illustrated below.

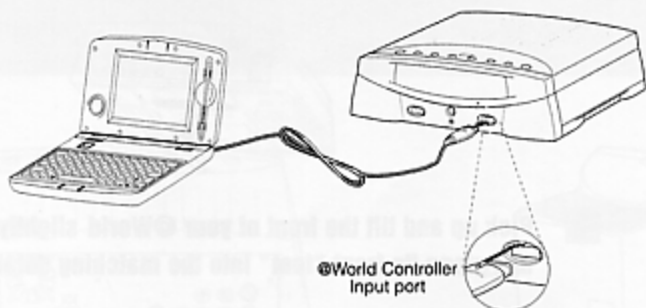

**WARNING** When using the built in graphics tablet on the @World keyboard, only use the plastic tip “stylus” that came with the keyboard. Using any other pen, pencil or sharp object could damage the surface of the tablet.

## Attaching a stacking expansion unit

The Floppy Dock is an external device that lets you add functionality to the @World. One example of a Floppy Dock unit is a disk storage device. It allows you to store data on 3 1/2 inch disks (also called *floppy disks*).

To attach a Floppy Dock to your @World, follow the procedure shown on the next page.

**WARNING** Turn off the @World and disconnect all cables before you attach the expansion unit. If you don't, the @World may malfunction.



- 1 Remove the door that covers the expansion unit connection. Place the door in a safe place. If you later decide to remove the expansion unit, you will need to attach the door again.**



- 2 Pick up and tilt the front of your @World slightly downward, and place its front "feet" into the matching detail in the expansion unit.**



- 3 Align the back end of the @World over the back end of the expansion unit. Press the @World down onto the expansion unit, until the player is firmly engaged.**



- 4 Snap the docking station's latch into place.**



When you're done, reconnect the audio and video cables.

## Connecting the @World to your VGA monitor

As an alternative to using your @World with your TV, you can connect it to a VGA computer monitor.

**WARNING** Before you connect the @World to your VGA monitor, make sure that they are both turned off.

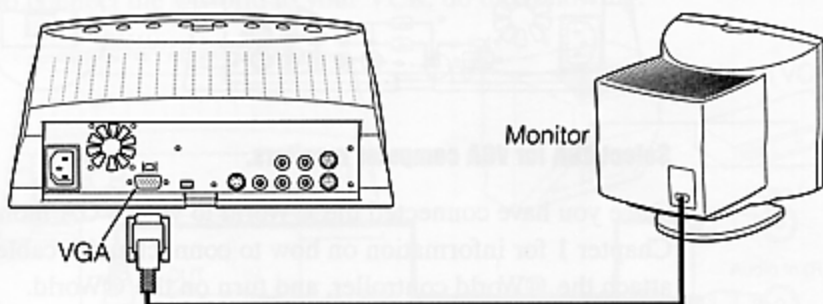

To connect a VGA monitor to your @World do the following:

- 1** Connect the monitor cable to the VGA monitor port on the back of your @World.
- 2** Tighten the thumbscrews on the connector.

You can prevent bad connections and accidental damage by tightening the thumbscrews.

## Selecting the appropriate video mode

Your @World supports three different video monitors: VGA computer monitors, NTSC TV sets, and PAL TV sets. Place the switch to the type of monitor that you are using.

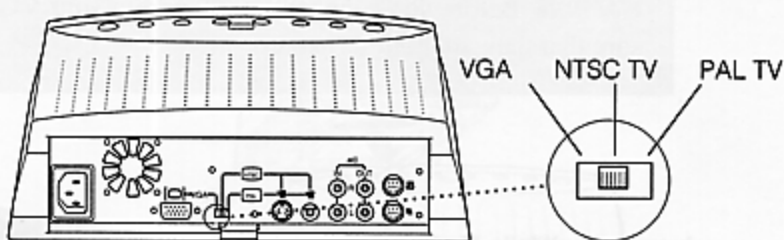

### Select VGA for VGA computer monitors.

Once you have connected the @World to your VGA monitor, return to Chapter 1 for information on how to connect audio cables to the @World, attach the @World controller, and turn on the @World.

## Connecting the @World to your VCR

If your TV doesn't have a video input jack, you can connect the @World to your VCR.

**WARNING** Before you connect the @World Power to your VCR, make sure that they are both turned off.

To connect the @World to your VCR, do the following:

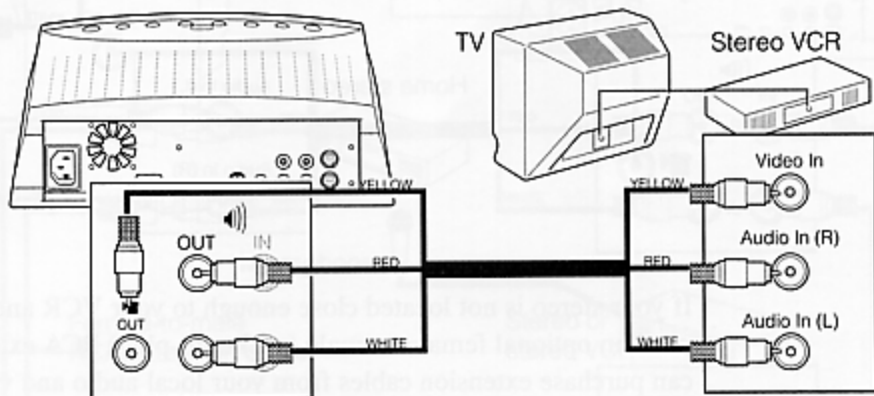

- 1** Insert one of the yellow plugs on the stereo audio/composite video cable into the video jack on the back of the @World.
- 2** Insert the other yellow plug into your VCR's video input jack.
- 3** Insert one of the red plugs into the right audio output jack, and one of the white plugs into the left audio output jack of the @World.
- 4** Insert the other red plug into the right audio input jack, and the other white plug into the left audio input jack of your VCR.

If your VCR doesn't have stereo sound, you can connect the audio cables to your home stereo, as shown here.

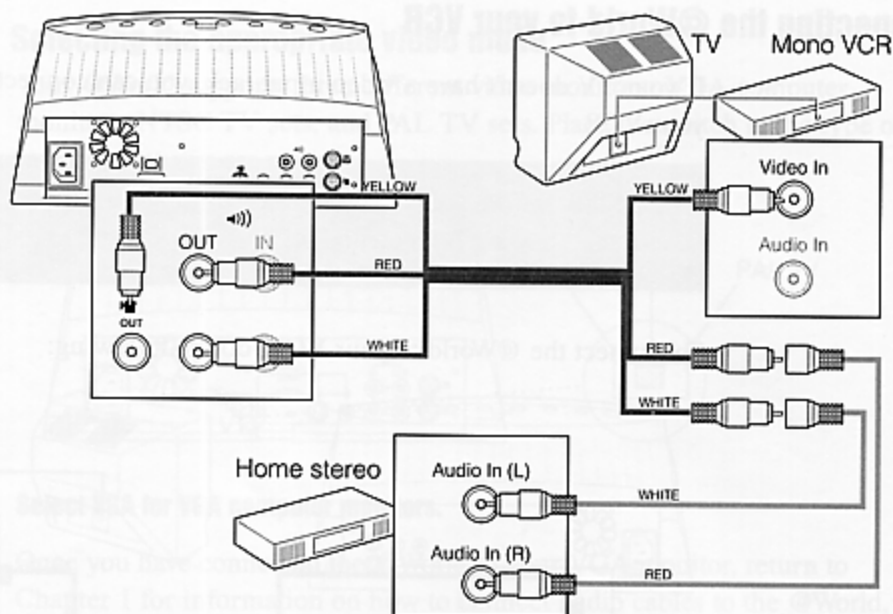

If your stereo is not located close enough to your VCR and @World, you may need an optional female-to-male (socket-to-plug) RCA extension cable. You can purchase extension cables from your local audio and video dealer.

If you are unsure how to set your home stereo to receive external audio input, please see the manual that came with your home stereo.

Once you have connected the @World to the VCR (and perhaps the home stereo), return to Chapter 1 for information on how to attach the @World controller and how to turn on the equipment.

## Routing sound to the @World

If you want to have sound going into your @World (for example, you want to play a Karaoke CD and sing along), you can connect audio cables from your stereo's audio output jacks to your unit's audio input jacks. You can then attach a microphone to your stereo.

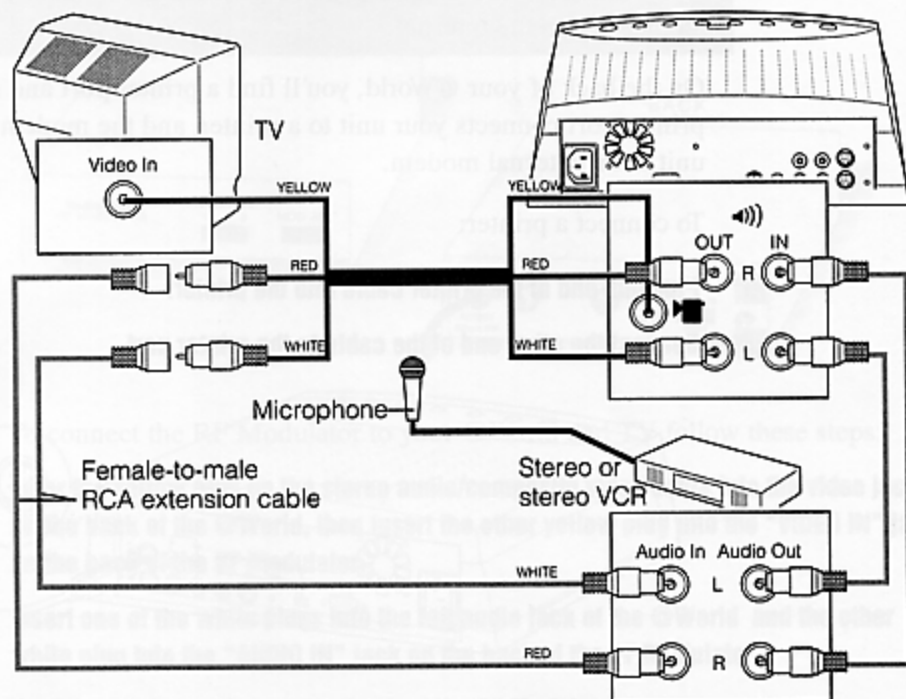

You can obtain additional audio cables from your local audio and video dealer.

## Connecting a modem and printer

This section illustrates where on your @World you can connect a modem and/or printer.

**IMPORTANT** Only selected printers and modems will work with your @World. For a complete list of the supported printers and modems, see the @World homepage on the internet.

On the back of your @World, you'll find a printer port and modem port. The printer port connects your unit to a printer, and the modem port connects your unit to an external modem.

To connect a printer:

- 1 Plug one end of the printer cable into the printer.**
- 2 Connect the other end of the cable to the printer port.**

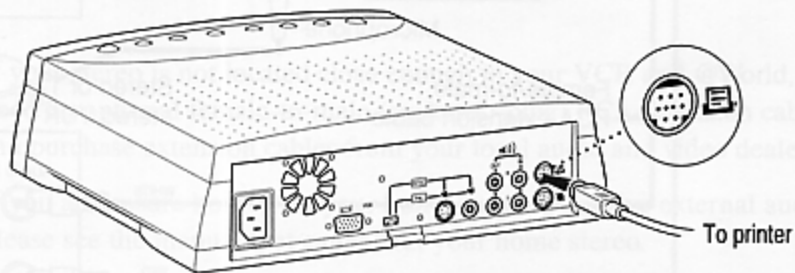

To connect a modem:

- 1 Connect the modem cable to the modem port.**

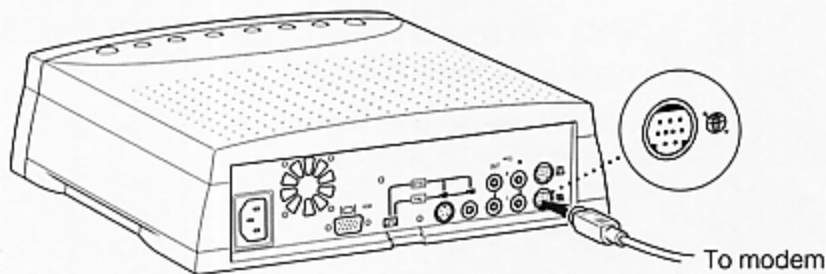

## Connecting an RF modulator to your @World

If your TV doesn't have a video input jack, and you do not have a VCR, you can connect directly to your television by obtaining an RF Modulator and a standard coax cable from the electronics supplier RadioShack. The catalog part number for the RF Modulator is 15-1283.

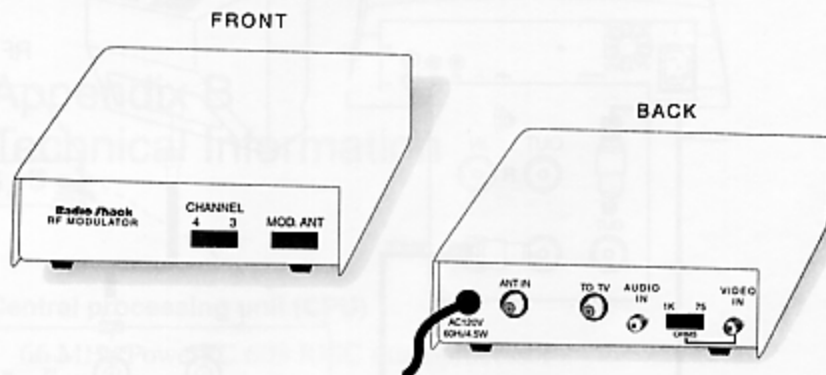

To connect the RF Modulator to your @World and TV follow these steps:

- 1** Insert the yellow plug on the stereo audio/composite video cable into the video Jack on the back of the @World, then insert the other yellow plug into the "VIDEO IN" Jack on the back of the RF Modulator.
- 2** Insert one of the white plugs into the left audio Jack of the @World and the other white plug into the "AUDIO IN" Jack on the back of the RF Modulator.
- 3** Set the "OHMS" switch on the back of the RF Modulator to "75".
- 4** Attach one end of the coax cable to the "TO TV" Jack on the back of the RF Modulator, and the other end to the "VHF/UHF" or "ANT IN" Jack on the back of your television.
- 5** Plug in the power cord of the RF Modulator to a power strip or wall outlet.
- 6** Set the "MOD. - ANT" switch on the front of the RF Modulator to "MOD." and the "CHANNEL" switch to the channel on your TV that you wish to use the @World on, (usually channel 3).

See illustration on next page.



## RF modulator "hook-up" illustration

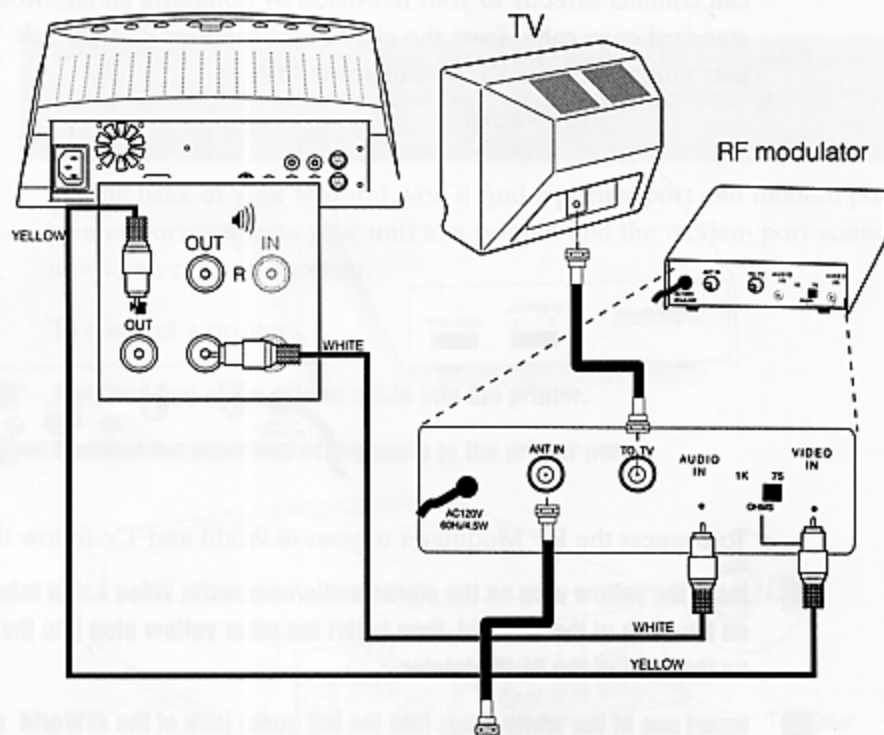

Reconnect to source previously connected to TV (Cablebox or VCR)

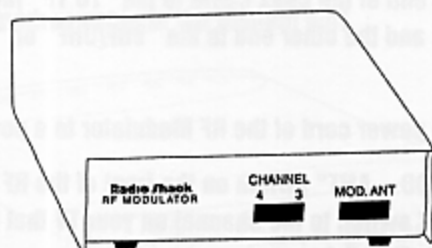

The **MOD.ANT** switch allows the user to switch between the @World (MOD.) or your TV/cable (ANT).

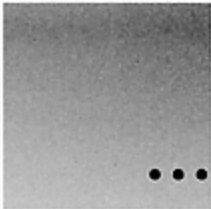

## Appendix B Technical Information

### Central processing unit (CPU)

- 66 MHz PowerPC 603 RISC microprocessor
- 64-bit internal superscalar architecture, three instructions per clock cycle
- 32-bit external superscalar architecture
- 8 KB data and 8 KB instruction caches
- IEEE standard single and double precision floating-point unit (FPU)
- Performance ratings:
  - SPECint92 rating is 60
  - SPECfp92 rating is 70

### Compact disc read-only memory (CD-ROM) drive

- |                                |                 |
|--------------------------------|-----------------|
| • Quadruple speed              | 600 KB          |
| • Random access time (typical) | < 200 ms        |
| • Random seek time             | < 167.5 ms      |
| • Burst speed                  | 3.5 MB/sec      |
| • Cache                        | 256 KB on-board |

### CD-ROM modes/formats supported

- Pippin CD
- Audio CD

### **Laser**

- Type: semiconductor GaAlAs laser
- Wavelength:  $790 \pm 25$  nanometers
- Output power: 0.14 milliwatts
- Beam divergence:  $53.5 \pm 1.5^\circ$

### **Weight**

- @World: 3.25 kg (7.15 lb.)
- @World controller: 198 g (7.0 oz)

### **Dimensions**

- @World  
265 mm wide x 271 mm deep x 90 mm high (10.4 in. x 10.7 in. x 3.5 in.)
- Hand-held controller  
160 mm wide x 103 mm deep x 54 mm high (6.3 in. x 4.0 in. x 2.1 in.)  
Cable length: 2.6m (101.5 in.)

### **Input ports**

- Two 10-pin Pippin/Apple Desktop Bus (P-ADB) ports
- Audio: left and right stereo 16-bit 44-kHz sampled input
- Serial: two standard serial ports

### **Output ports**

- Video: composite video output and S-video output, NTSC or PAL selectable
- VGA monitor port
- Audio: left and right stereo 16-bit 44-kHz sampled output
- Headphone: mini-stereo jack

### **Expansion ports**

- Memory expansion port: 68-pin connector for external memory expansion module (X-Mem)
- Expansion port: 120-pin edge connector for (X-PCI) stacking expansion unit